

Honeywell

Dolphin[®] 7850 Mobile Computer

With Windows Mobile[®] 5.0

User's Guide

Disclaimer

Honeywell International Inc. (“HII”) reserves the right to make changes in specifications and other information contained in this document without prior notice, and the reader should in all cases consult HII to determine whether any such changes have been made. The information in this publication does not represent a commitment on the part of HII.

HII shall not be liable for technical or editorial errors or omissions contained herein; nor for incidental or consequential damages resulting from the furnishing, performance, or use of this material.

This document contains proprietary information that is protected by copyright. All rights are reserved. No part of this document may be photocopied, reproduced, or translated into another language without the prior written consent of HII.

©2006–2010 Honeywell International Inc. All rights reserved.

Web Address: www.honeywellaidc.com

Trademarks

Dolphin, Dolphin RF, HomeBase, Mobile Base, and QuadCharger are trademarks or registered trademarks of Hand Held Products, Inc. or Honeywell International Inc.

Microsoft, Windows, Windows Mobile, Windows CE, Windows NT, Windows 2000, Windows ME, Windows XP, ActiveSync, Outlook, and the Windows logo are trademarks or registered trademarks of Microsoft Corporation.

Other product names mentioned in this manual may be trademarks or registered trademarks of their respective companies and are the property of their respective owners.

Patents

Please refer to the product packaging for a list of patents.

Other Trademarks

The Bluetooth trademarks are owned by Bluetooth SIG, Inc., U.S.A. and licensed to Honeywell International Inc.



Table of Contents

Chapter 1 - Agency Information

Label Locations	1-1
Regulatory and Safety Approvals for all Dolphin Terminals	1-3

Chapter 2 - Getting Started

Out of the Box	2-1
Today Screen.....	2-2
Navigation Bar	2-2
Using the Stylus	2-3
Pop-Up Menus	2-3

Chapter 3 - Hardware Overview

Standard Terminal Configuration	3-1
Peripherals	3-2
Accessories	3-3
Front Panel Features	3-4
Back Panel Features	3-5
Side Panel Features	3-6
Battery Door Tether (Optional)	3-7
I/O Connector.....	3-9
Rubber Bumpers	3-10
Battery Power	3-11
Main Battery Pack	3-11
Internal Backup Battery	3-12
Resetting the Terminal.....	3-15
Soft Reset (Warm Boot)	3-15
Hard Reset (Cold Boot).....	3-15
Suspend Mode.....	3-15
Terminal Technical Specifications	3-17

Chapter 4 - Using the Keyboards

Overview	4-1
Using the Function Keys	4-2
Using the Navigation Keys	4-3
Using the Modifier Keys	4-3
Keyboard Mode Indicator.....	4-3
24-Key Keyboard	4-4
Toggling Between Alpha and Numeric Modes	4-4
24-Key Keyboard Numeric Key Combinations.....	4-5
24-Key Keyboard Alpha Key Combinations	4-6
38-Key Keyboard	4-7
Toggling Between Numeric and Alpha Modes	4-7
ALT & CTRL Functionality.....	4-7
38-Key Keyboard Alpha Key Combinations	4-8
38-Key Keyboard Numeric Key Combinations.....	4-10

Chapter 5 - Using the Imager Scanner Engine

Overview.....	5-1
Available Engines	5-1
Available Laser Engines	5-2
Laser Specifications	5-2
Supported Bar Code Symbologies	5-3
Activating the Engine.....	5-4
Decoding	5-5
Capturing Images	5-7

Chapter 6 - System Settings

Overview.....	6-1
Personal Settings	6-2
Buttons.....	6-3
Menus - Modifying the Start Menu.....	6-5
System Settings.....	6-7
About	6-7
Backlight	6-8
Memory.....	6-10
Power.....	6-12
Remove Programs.....	6-14
Screen	6-15

Chapter 7 - Communication

Communication Options	7-1
Default COM Port Assignments.....	7-2
Installing Additional Software	7-2
Using ActiveSync.....	7-3
Adding Programs via ActiveSync.....	7-4
Connections Tab	7-6
Connecting the Terminal to a Wireless Network	7-7
Connecting the Terminal to an ISP.....	7-7
Adding Programs From the Internet	7-7
Using Infrared Communication	7-8
Connections Manager	7-10
Network Cards.....	7-12
Radio Manager.....	7-13
USB to PC	7-15

Chapter 8 - Wireless PAN Communication with Bluetooth

Bluetooth Radio	8-1
Enabling the Bluetooth Radio	8-1
BTE Explorer.....	8-1
Accessing BTE Explorer	8-2
Using BTE Explorer	8-3
Connection Types.....	8-7
Device Types.....	8-8
View Options	8-8

Menu Options	8-9
Discovered Devices	8-10
Refreshing Discovered Devices.....	8-10
Making the Terminal Discoverable	8-10
Pairing	8-13

Chapter 9 - Dolphin HomeBase Device

Overview.....	9-1
Front Panel	9-2
Back Panel	9-3
Bottom Panel Dimensions	9-4
Power	9-5
Charging the Main Battery.....	9-7
ActiveSync Communication.....	9-8
RS-232 Cables	9-9
Mounting.....	9-10
Wall Mounting.....	9-11

Chapter 10 - Dolphin QuadCharger Device

Overview.....	10-1
Front Panel	10-2
Back Panel	10-3
Inserting and Removing Battery Packs	10-3
Supplying Power.....	10-3
Charging Batteries.....	10-4
Recommendations for Storing Batteries.....	10-4
Using the Battery Analyzer	10-5
Bottom Panel	10-6
Mounting.....	10-6
Troubleshooting.....	10-7

Chapter 11 - Dolphin ChargeBase Device

Overview.....	11-1
Front Panel	11-2
Back Panel	11-3
Power Supply.....	11-3
Supplying Power to the ChargeBase.....	11-4
Inserting and Removing Terminals.....	11-4
Charging Terminals in the ChargeBase	11-5
Mounting the ChargeBase.....	11-6

Chapter 12 - Cables Kits

Universal Cable Features.....	12-1
Using the Power Cable.....	12-2
Using the Mobile Charger.....	12-3
Using the Comm/Charge Cable.....	12-4

Chapter 13 - Customer Support and Warranty

Technical Assistance	13-1
Online Technical Assistance.....	13-1
Product Service and Repair.....	13-1
Online Product Service and Repair Assistance	13-2
Limited Warranty	13-2
How to Extend Your Warranty	13-3

Agency Information

Label Locations

Dolphin 7850 mobile computers meet or exceed the requirements of all applicable standards organizations for safe operation. However, as with any electrical equipment, the best way to ensure safe operation is to operate them according to the agency guidelines that follow. Please read these guidelines carefully before using your Dolphin mobile computer.

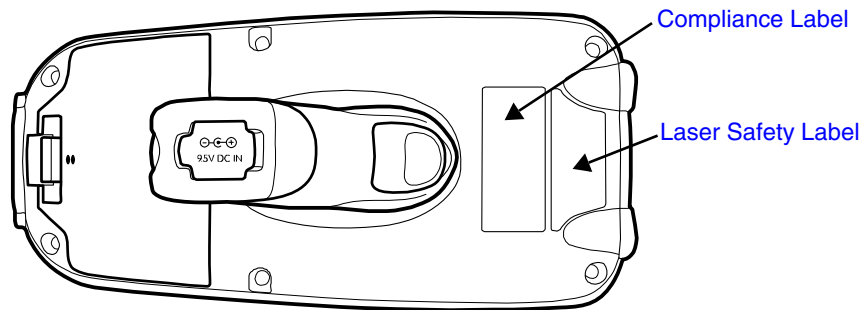

Dolphin 7850 802.11b/g (WLAN) & Bluetooth

Dolphin 7850 RF terminals are designed to comply with the most current applicable standards on safe levels of RF energy developed by the Institute of Electrical and Electronics Engineers (IEEE) and the American National Standards Institute (ANSI) and has been recommended for adoption by the Federal Communications Commission (FCC).

R&TTE Compliance Statement—802.11b/g (WLAN) and/or Bluetooth

Dolphin RF terminals are in conformity with all essential requirements of the R&TTE Directive (1999/5/EC). This equipment has been assessed to the following standards as applicable:

Parameter	Specification
R&TTE	EN 300 328-2:2000
	EN 301 489-1 (2002-08)
	EN 301 489-17 (2002-08)
	EN 60950:2000
	EN 50361:2001

This product is marked with **CE0682** in accordance with the Class II product requirements specified in the R&TTE Directive, 1999/5/EC. The equipment is intended for use throughout the European Community. PAN European Frequency Range: 2.402—2.480 GHz.

Restrictions in France are as follows:

- Indoor use: Maximum power (EIRP*) of 100 mW for the entire 2.400—2.4835 GHz
- Outdoor use: Maximum power (EIRP*) of 100 mW for the 2.400—2.454 GHz band and maximum power (EIRP*) of 10 mW for the 2.454—2.483 GHz band

For further information, please contact:

Honeywell Imaging & Mobility Europe BV
 Nijverheidsweg 9
 5627 BT Eindhoven
 The Netherlands

Honeywell shall not be liable for use of our product with equipment (i.e., power supplies, personal computers, etc.) that is not CE marked and does not comply with the Low Voltage Directive.

Laser Safety Label

If the following label is attached to your product, it indicates the product contains a laser engine or laser aimer:

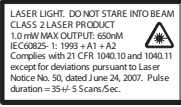
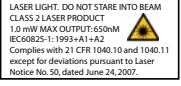
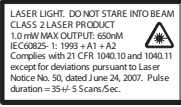
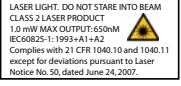
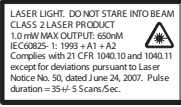
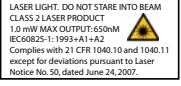
<p>Laser Safety Label</p> <p>If the following label is attached to your product, it indicates the product contains a laser engine or laser aimer:</p> <p>Hinweis zur Augensicherheit von Lasergeräten</p> <p>Wenn Ihr Produkt mit dem folgenden Etikett gekennzeichnet ist, bedeutet dies, dass das Produkt eine Laserengine oder einen Laser-Zielstrahl enthält:</p>	<table border="0"><tr><td data-bbox="824 501 1039 911"><p>SE1200 Laser Scan Engine</p><p>LASER LIGHT. DO NOT STARE INTO BEAM CLASS 2 LASER PRODUCT 1.0 mW MAX OUTPUT: 650nm IEC60825-1: 1993+A1+A2 Complies with 21 CFR 1040.10 and 1040.11 except for deviations pursuant to Laser Notice No. 50, dated June 24, 2007. Pulse duration = 35µs - 5 Scans/Sec.</p></td><td data-bbox="1039 501 1484 911"><p>Image Engines with Integrated Laser Aimers</p><p>LASER LIGHT. DO NOT STARE INTO BEAM CLASS 2 LASER PRODUCT 1.0 mW MAX OUTPUT: 650nm IEC60825-1: 1993+A1+A2 Complies with 21 CFR 1040.10 and 1040.11 except for deviations pursuant to Laser Notice No. 50, dated June 24, 2007.</p></td></tr></table>	<p>SE1200 Laser Scan Engine</p>  <p>LASER LIGHT. DO NOT STARE INTO BEAM CLASS 2 LASER PRODUCT 1.0 mW MAX OUTPUT: 650nm IEC60825-1: 1993+A1+A2 Complies with 21 CFR 1040.10 and 1040.11 except for deviations pursuant to Laser Notice No. 50, dated June 24, 2007. Pulse duration = 35µs - 5 Scans/Sec.</p>	<p>Image Engines with Integrated Laser Aimers</p>  <p>LASER LIGHT. DO NOT STARE INTO BEAM CLASS 2 LASER PRODUCT 1.0 mW MAX OUTPUT: 650nm IEC60825-1: 1993+A1+A2 Complies with 21 CFR 1040.10 and 1040.11 except for deviations pursuant to Laser Notice No. 50, dated June 24, 2007.</p>
<p>SE1200 Laser Scan Engine</p>  <p>LASER LIGHT. DO NOT STARE INTO BEAM CLASS 2 LASER PRODUCT 1.0 mW MAX OUTPUT: 650nm IEC60825-1: 1993+A1+A2 Complies with 21 CFR 1040.10 and 1040.11 except for deviations pursuant to Laser Notice No. 50, dated June 24, 2007. Pulse duration = 35µs - 5 Scans/Sec.</p>	<p>Image Engines with Integrated Laser Aimers</p>  <p>LASER LIGHT. DO NOT STARE INTO BEAM CLASS 2 LASER PRODUCT 1.0 mW MAX OUTPUT: 650nm IEC60825-1: 1993+A1+A2 Complies with 21 CFR 1040.10 and 1040.11 except for deviations pursuant to Laser Notice No. 50, dated June 24, 2007.</p>		

Laser Eye Safety Statement: This device has been tested in accordance with and complies with EN60825-1: 1993+A1+A2 and 21 CFR 1040.10 and 1040.11, except for deviations pursuant to Laser Notice No. 50, dated June 24, 2007. LASER LIGHT, DO NOT STARE INTO BEAM, CLASS 2 LASER PRODUCT, 1.0 mW MAX OUTPUT: 650nm.

Caution - use of controls or adjustments or performance of procedures other than those specified herein may result in hazardous radiation exposure.

Dieses Gerät wurde geprüft und erfüllt die Anforderungen von IEC60825-1: 1993+A1+A2 und 21 CFR 1040.10 und 1040.11, mit Ausnahme von Abweichungen gemäß Laser Notice Nr. 50 vom 24. Juni 2007.

LASERSTRAHLUNG, NICHT IN DEN STRAHL BLICKEN, LASERPRODUKT DER KLASSE 2, MAXIMALE ENERGIE DER LASERSTRAHLUNG 1,0 mW: 650 nm.

Die missbräuchliche Bedienung oder Modifikation des Gerätes bzw. die Ausführung von anderen als in dieser Bedienungsanleitung beschriebenen Abläufen kann zu gefährlicher Laserstrahlung führen.

LED Safety Statement

This device has been tested in accordance with IEC60825-1 LED safety, and has been certified to be under the limits of a Class 1 LED device.

Hinweis zur Lasersicherheit

Dieses Gerät wurde gemäß IEC60825-1: 1993+A1+A2, Sicherheit von Lasereinrichtungen, geprüft und als Laserprodukt der Klasse 1 eingestuft.

Infrared LED Safety Statement

Caution - Class 1M LED radiation when open. Do not view directly with optical instruments. The maximum output power for the IR LED is 145.1uW.

Infrarot LED Sicherheitsanweisung

Vorsicht - Nicht mit einem Vergrößerungsglas in optische Geräte blicken.

Die maximale Ausgangsleistung für die IR LED ist 145,1 uW. LED's werden bei einer Frequenz von 115,200 Hz mit einem Auslastungsgrad von 18,75% gepulst, wobei die Einschaltdauer eines einzelnen Impulses 1.6275×10^{-6} Sekunden beträgt.

Regulatory and Safety Approvals for all Dolphin Terminals

Parameter	Specification
U.S.A.	FCC Part 15, Class B
Canada	ICES-003
European Community	EN 55022 (CISPR 22) Class B EN60950:2000 EN60825-1:1994 + A11 + A2 EN55024:1998

 The CE Mark on the product indicates that the system has been tested to and conforms with the provisions noted within the 89/336/EEC Electromagnetic Compatibility Directive and the 73/23/EEC and 93/68/EEC Low Voltage Directive.

Dolphin RF Terminal—802.11b/g (WLAN) and/or Bluetooth

This device complies with Part 15 of the FCC Rules. Operation is subject to the following two conditions: (1) this device may not cause harmful interference, and (2) this device must accept any interference received, including interference that may cause undesired operation.

This equipment has been tested and found to comply with the limits for a Class B digital device pursuant to Part 15 of the FCC Rules. These limits are designed to provide reasonable protection against harmful interference in a residential installation. This equipment generates, uses, and can radiate radio frequency energy and, if not installed and used in accordance with the instructions, may cause harmful interference to radio communications. However, there is no guarantee that interference will not occur in a particular installation. If this equipment does cause harmful interference to radio or television reception, which can be determined by turning the equipment off and on, the user is encouraged to try to correct the interference by one or more of the following measures:

- Reorient or relocate the receiving antenna.
- Increase the separation between the equipment and receiver.
- Connect the equipment into an outlet on a circuit different from that to which the receiver is connected.
- Consult the dealer or an experienced radio/TV technician for help.

If necessary, the user should consult the dealer or an experienced radio/television technician for additional suggestions. The user may find the following booklet helpful: "Something About Interference." This is available at FCC local regional offices. Our company is not responsible for any radio or television interference caused by unauthorized modifications of this equipment or the substitution or attachment of connecting cables and equipment other than those specified by our company. The correction is the responsibility of the user. Use only shielded data cables with this system.

In accordance with FCC 15.21, changes or modifications not expressly approved by Honeywell may void the FCC authorization to operate the equipment.

CAUTION! Any changes or modifications not expressly approved by the grantee of this device could void the user's authority to operate the equipment.

For body worn operation, this device has been tested and meets the FCC RF exposure guidelines when used with the Honeywell Dolphin accessories supplied or designated for this product. Use of other accessories may not ensure compliance with FCC RF exposure guidelines.

RF, Regulatory, and Safety Agency Approvals—802.11b/g (WLAN) and/or Bluetooth

Parameter	Specification
U.S.A.	FCC Part 15.247
Canada	RSS 210

Canadian Compliance

This Class B digital apparatus complies with Canadian ICES-003. Operation is subject to the following two conditions: (1) this device may not cause harmful interference, and (2) this device must accept any interference received, including interference that may cause undesired operation.

To prevent radio interference to the licensed service, this device is intended to be operated indoors and away from windows to provide maximum shielding. Equipment (or its transmit antenna) installed outdoors is subject to licensing.

Cet appareil numérique de la Classe B est conforme à la norme NMB-003 du Canada.

For European Community Users

Honeywell complies with Directive 2002/96/EC OF THE EUROPEAN PARLIAMENT AND OF THE COUNCIL of 27 January 2003 on waste electrical and electronic equipment (WEEE).

Waste Electrical and Electronic Equipment Information

This product has required the extraction and use of natural resources for its production. It may contain hazardous substances that could impact health and the environment, if not properly disposed.

In order to avoid the dissemination of those substances in our environment and to diminish the pressure on the natural resources, we encourage you to use the appropriate take-back systems for product disposal. Those systems will reuse or recycle most of the materials of the product you are disposing in a sound way.

 The crossed out wheeled bin symbol informs you that the product should not be disposed of along with municipal waste and invites you to use the appropriate separate take-back systems for product disposal.

If you need more information on the collection, reuse, and recycling systems, please contact your local or regional waste administration.

You may also contact your supplier for more information on the environmental performances of this product.

Pacemakers, Hearing Aids and Other Electrically Powered Devices

Most manufacturers of medical devices adhere to the IEC 601-1-2 standard. This standard requires devices to operate properly in an EM Field with a strength of 3V/m over a frequency range of 26 to 1000MHz. The maximum allowable field strength emitted by the Dolphin terminal is 0.3V/m according to Subpart B of Part 1 of the FCC rules. Therefore, the Dolphin RF terminal has no effect on medical devices that meet the IEC specification.

Microwaves

The radio in the Dolphin RF terminal operates on the same frequency band as a microwave oven. Therefore, if you use a microwave within range of the Dolphin RF terminal you may notice performance degradation in your wireless network. However, both your microwave and your wireless network will continue to function. The Dolphin Batch terminal does not contain a radio, and therefore, is not affected by microwave ovens.



Out of the Box

When you open the carton, please verify that the carton contains the following items:

- Dolphin 7850 mobile computer (the terminal)
- Main battery pack (7.4v, li-ion)
- Getting Started CD-ROM
- Dolphin 7850 Mobile Computer Quick Start Guide

Be sure to keep the original packaging in the event that the Dolphin terminal should need to be returned for service. For details, see [Limited Warranty](#) on page 13-2.

If you ordered additional peripherals and accessories, verify that they are included with the order.

Step 1. Install the Main Battery Pack

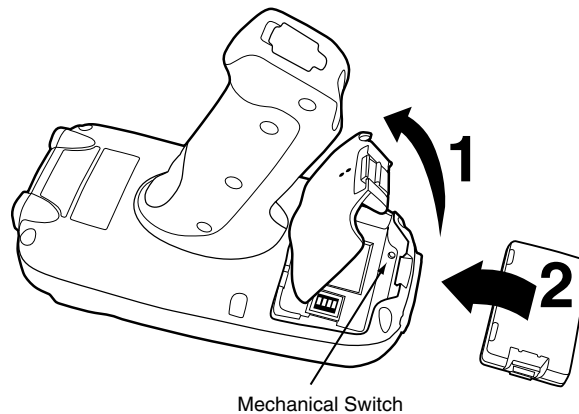

You must re-attach the battery door! This terminal contains a mechanical switch under the battery door that prevents the terminal from initializing unless the battery door is closed.

For detailed information about installing and charging batteries, see [Battery Power](#) on page 3-11.

Step 2. Charge the Batteries

There are two types of battery power: the main battery pack and the backup battery located inside the terminal. The main battery pack powers the terminal and charges the internal backup battery.

Dolphin terminals ship with both batteries discharged of power. **Charge the main battery pack for a minimum of four(4) hours before initial use!**

You can use one of the following charging peripherals:

- Dolphin HomeBase Device
- Dolphin QuadCharger Device
- AC Adapter Cable

Step 3. Boot the Terminal

The terminal begins booting as soon as power is applied and runs by itself. Do NOT press any keys or interrupt the boot process.

When the boot process is complete, the Today screen appears and the terminal is ready for use.

Today Screen

Initial boot and system resets end on the Today screen; see [Resetting the Terminal](#) on page 3-15.

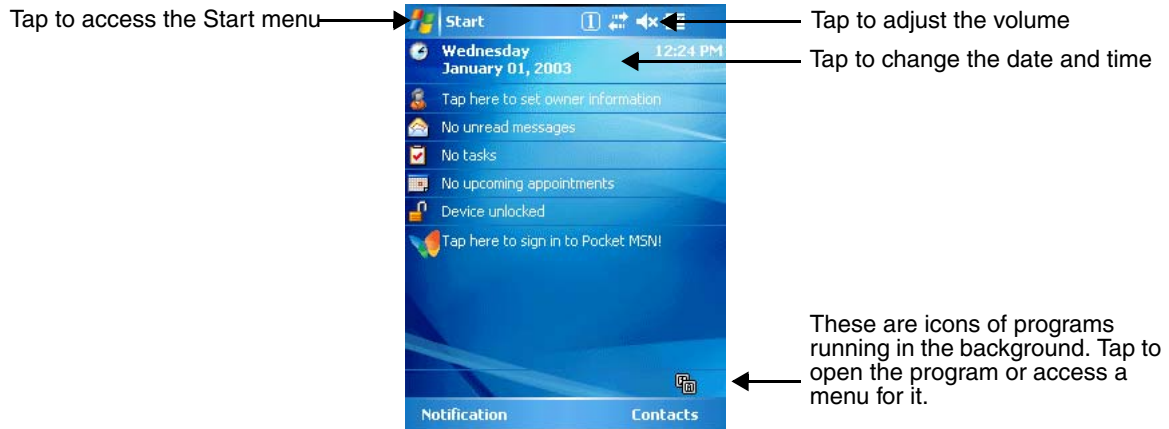

Note: You can also open the Today screen at any time by tapping Start > Today.

Navigation Bar

Located at the top of every screen, the Navigation bar provides access to the Start menu, shows the current time (from the system clock), and displays both status and keyboard status icons.

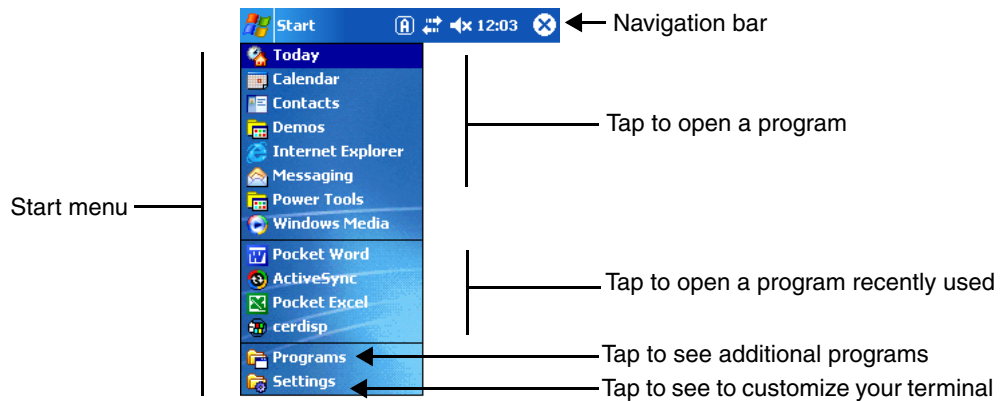

Command Bar

Located at the bottom of application screens, the Command bar includes application menus, buttons, and provides access to the Soft Input Panel (SIP).



The contents of the Command bar changes according to the open application.

Using the Stylus

Use the stylus or your finger to select or enter information on the touch panel. The stylus functions as a mouse; generally, a tap is the same as a click.

- Tap** Tap the touch panel once to open menu items and select options.
- Drag** Hold the stylus on the screen and drag across the screen to select text and images.
- Tap & hold** Tap and hold the stylus on an item and a pop-up menu appears. On the pop-up menu, tap the action of the task you want to perform.



Using sharp objects, such as paper clips, pencils, or ink pens can damage the touch panel and may cause damage not covered by the warranty. For more information about the touch panel, see [Touch Panel Display](#) on page 3-4.

Selecting Programs

The Start menu does not fit all installed programs. To see additional programs, tap **Start > Programs**. To open a program, tap once on the icon.

Pop-Up Menus

With pop-up menus, you can quickly choose an action for an item.

1. Tap and hold the stylus on the item name. The pop-up menu appears.
2. Lift the stylus, and tap the action you want to perform.

Note: To close the menu without performing an action, tap the screen anywhere outside the menu.

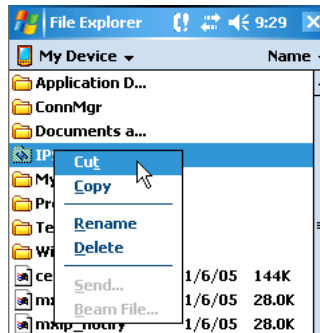

The contents of pop-up menus depend change according to the program you're in.

Searching for Information

You can use the Search feature or File Explorer to find and organize information. Tap **Start > Programs > Search**. Enter the text you want to find and tap **Search**.

The Results section displays the search results.

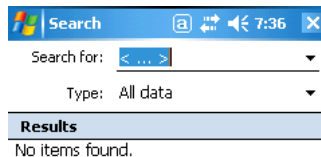



There are a number of standard configurations as well as charging and communication peripherals and accessories to maximize the efficiency of your application setting.

Standard Terminal Configuration

- Windows Mobile 5.0
- PXA270 520MHz processor
- 64MB volatile system memory for running programs & 64MB non-volatile Flash memory for storing data
- 24-key calculator-style numeric with scrolling alpha or 38-key calculator-style numeric with full alpha
- 3.5 in. 1/4 VGA 240 x 320 TFT color display with hard-coat industrial touch panel
- 5300 or 5100 Standard Range (SR) scan engine
- WLAN radio (Wi-Fi certified)
- Bluetooth radio

Additional Configuration Options

The Dolphin 7850 terminal offers you a number of configuration options to customize the terminal to your business needs.

System Memory [Memory](#) (see page 6-10)

Scan Engines 5100SR/SF VGA Area Imagers with bright green LED aimer
5300SR/SF VGA Area Imagers with High-Vis aiming pattern
5300HD VGA Area Imagers with High-Vis aiming pattern
For more information, see [Available Engines](#) on page 5-1.

Laser Engines Options

HP (High Performance) scanner
LR (Long Range) scanner
ALR (Advanced Long Range) scanner
For more information, see [Available Laser Engines](#) on page 5-2.

Peripherals

The following items are sold separately and enhance the capabilities of your Dolphin terminal.

Dolphin HomeBase™ Device

This charging and communication cradle supports both RS-232 and USB communication, enabling your terminal to interface with the majority of PC-based enterprise systems. When a terminal is seated in the HomeBase device, its main battery pack charges in less than four(4) hours.

For more information, see [Dolphin HomeBase Device](#) on page 9-1.

Dolphin QuadCharger™ Device

This four(4)-slot charging station for Li-ion battery packs can charge each battery in less than four(4) hours. The fourth slot features a battery analyzer that completely resets and re-calibrates a battery, then displays remaining capacity.

For more information, see [Dolphin QuadCharger Device](#) on page 10-1.

Cables Kits

There are a number of cable kits that enable you to charge and communicate with other devices.

For more information, see [Cables Kits](#) on page 12-1.

Dolphin ChargeBase

This charging bay holds up to four(4) Dolphin 7850 terminals.

For more information, see [Dolphin ChargeBase Device](#) on page 11-1.

Mobile Mount

The Mobile Mount is a plastic cradle and RAM mount that holds and positions the terminal and can be mounted on a fork truck, pallet lift, or other stable, stationary surface.

Accessories

The following items are sold separately and enhance the capabilities of your Dolphin terminal.

Battery Door Tether

For more information, see [Battery Door Tether \(Optional\)](#) on page 3-7.

Holster

The holster holds one terminal around the waist.

Li-ion Battery Pack

These are 7.4Vdc, 14.1 watt hour Li-ion replacement battery packs; see [Battery Power](#) on page 3-11.

Protective Cover

The protective cover wraps around the terminal to protect it from wear and tear.

Protective Rubber Boot

The protective rubber boot wraps tightly around the terminal for added durability.

Screen Protectors

This is a pack of screen protectors that fit the touch panel display.

Stylus Three-Pack

This is a pack of three extra styluses.

Tote/Carry Bag

The tote and carry bag holds one terminal, a spare battery, and small printer. It can be shoulder-worn, waist-worn, or carried by hand.

Wrist Lanyard/Stylus Tether

For more information, see [Wrist Lanyard/Stylus Tether \(Optional\)](#) on page 3-7.

Front Panel Features

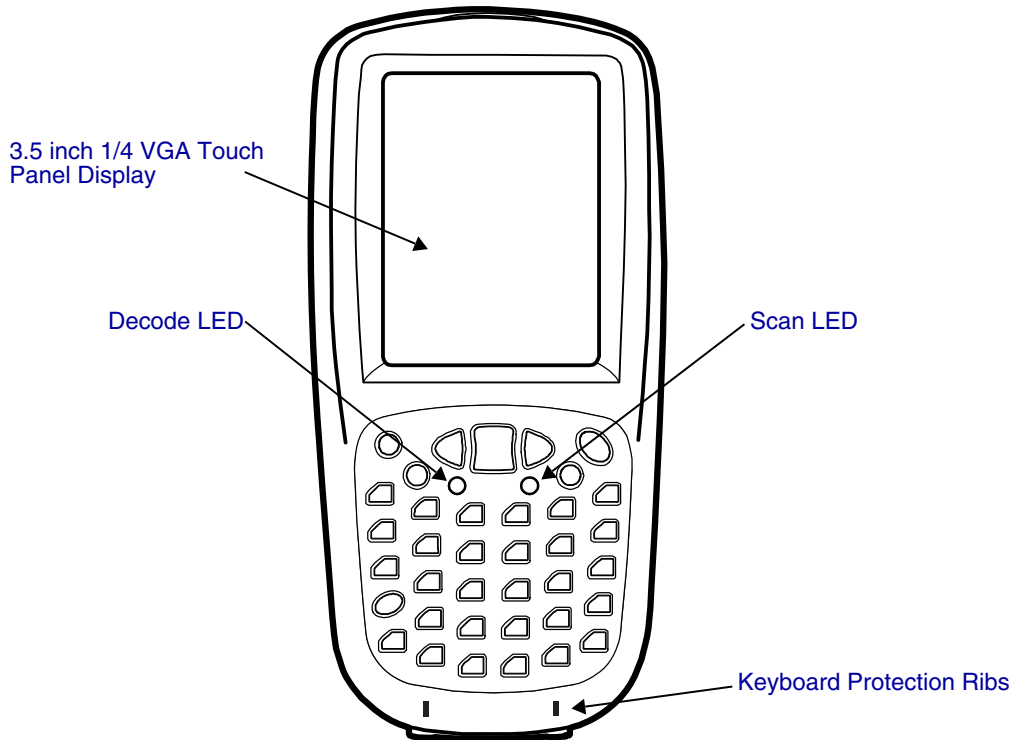

Decode and Scan LEDs

The Scan LED lights red when you press the Scan trigger in scanning applications. The Decode LED lights green when a scanned bar code is successfully decoded. For more information, see [LEDs](#) on page 4-1.

Keyboard Protection Ribs

These ribs protect the keyboard and prevent keys from being pressed accidentally when the terminal is placed facedown on a flat surface. For a complete overview of each keyboard, see [Using the Keyboards](#) on page 4-1.

Touch Panel Display

The 3.5 inch 1/4 VGA (Video Graphic Array) display is a transfective color LCD (Liquid Crystal Display) in TFT (Thin Film Transistor) color with a 240 x 320 resolution. The LCD is covered by an industrial touch screen lens for maximum durability and backlit for maximum viewability; see [Backlight](#) on page 6-8.

For touch panel input, use the stylus included with the terminal or your finger. The method you choose depends on which one is most appropriate for your application. While there is a great deal of variation in different applications, use of the supplied stylus provides greater touch screen accuracy; see [Using the Stylus](#) on page 2-3.

Dolphin terminals ship with screen protectors already installed. Screen protectors help prevent wear and damage to the touch panel; especially when used with applications that require high-volume interfacing with the touch panel. Screen protectors are subject to wear and tear. Therefore, inspect screen protectors regularly and replace them when worn or punctured.



Using sharp objects, such as paper clips, pencils, or ink pens and may cause damage not covered by the warranty.

Back Panel Features

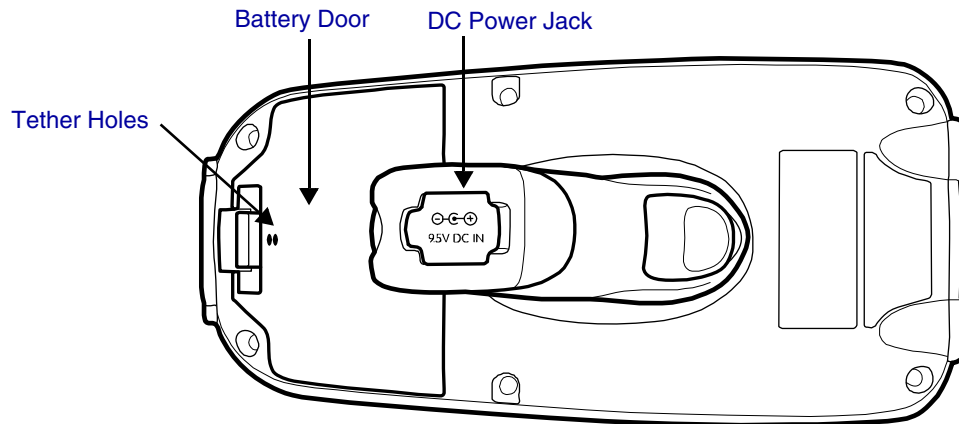

Battery Door

The battery door covers and secures the main battery pack in the battery well. There is a mechanical switch on the terminal under this door that puts the terminal in suspend mode (see page 3-15) while the battery door is open. This door must be closed for the terminal to resume operation. For more information, see [Installing the Main Battery Pack](#) on page 3-11.

DC Power Jack

Located on the bottom of the pistol-grip handle, the 9.5V DC power jack receives external power from the Dolphin Power Cable. When connected to the Power Cable, the terminal is powered and the main battery pack is charging. For more information, see [Using the Power Cable](#) on page 12-2.

Tether Holes

These holes are an attachment point for the [Battery Door Tether \(Optional\)](#) (see page 3-7).

Side Panel Features

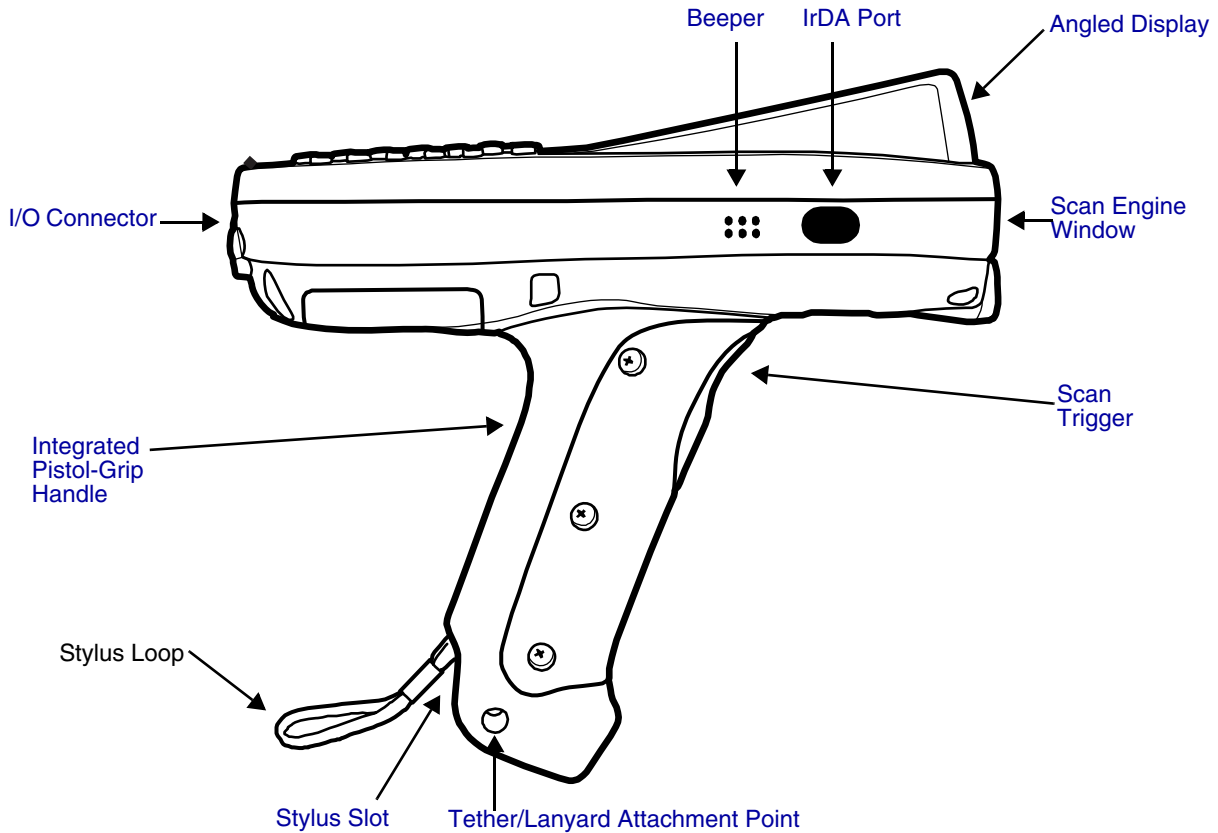

Note: This graphic shows the right side of the Dolphin 7850 terminal.

Angled Display

The touch panel display (see page 3-4) tilts up toward the user, which improves application viewing when operating the terminal and reduces glare. Most important, the tilted display helps you read decoded data without having to tilt your wrist.

Beeper

The beeper provides an audible indication of application events such as decoding (to indicate a good or bad scan), touch panel touches, and keyboard input.

Scan Engine Window

The scan engine window provides an opening for the imager scanner engines and points straight out of the device. Simply point and scan.

There are several scan engine configurations available; see [Using the Imager Scanner Engine](#) on page 5-1.

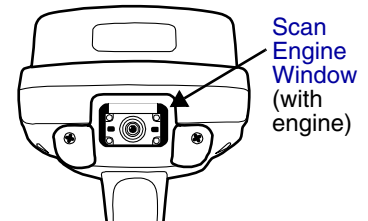

Integrated Pistol-Grip Handle

The pistol-grip handle is integrated into the terminal and is not removable, which makes the unit more durable in the field. This handle is contoured so that the terminal is comfortable in your hand and balanced during operations.

IrDA Port

The infrared port is IrDA-enabled (Infrared Data Association) and communicates with other IrDA-enabled devices such as PCs, printers, modems, or other Dolphin 7850 terminals. The maximum data transfer speed is 115 Kbps with a duty cycle of 18.75%. For more information, see [Using Infrared Communication](#) on page 7-8.

Scan Trigger

The front of the pistol-grip handle contains a scan trigger that activates the scan engine. The scan trigger also wakes the terminal from [Suspend Mode](#) (see page 3-15).

Stylus Slot

Dolphin 7850 terminals ship with a stylus inserted into the pistol-grip handle. Stores the stylus in this slot when you're not using it. For more information about the stylus, see [Using the Stylus](#) on page 2-3.

Tether/Lanyard Attachment Point

You can string optional hardware accessories through this hole to fasten hardware to the terminal.



Wrist Lanyard/Stylus Tether (Optional)

The optional lanyard loops around your wrist and attaches the stylus to the terminal. One end loops through the attachment point at the bottom of the handle and the other end loops around the hook at the end of the stylus.

When the stylus is inserted into the stylus slot, you can insert your wrist for extra security while operating the terminal. When the stylus is removed from the stylus slot, the stylus remains attached to the terminal to prevent you from losing the stylus if you accidentally drop it.

Battery Door Tether (Optional)

The optional battery door tether ensures that the battery door remains attached to the terminal even when it is removed from the battery well. There are two pieces: the clip and the leather strap.

1. Put the terminal in Suspend mode by pressing and holding Blue  + Backlight  keys.
2. Disconnect the two pieces of the battery door tether; gently squeeze the outside of the clip and pull the leather strap out of the clip.
3. Take the leather strap and loop the lanyard portion through the attachment point on the handle as shown below.

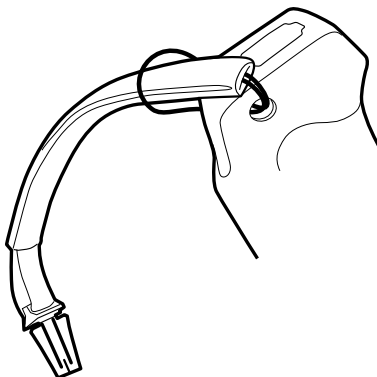

4. Remove the battery door.

5. Take the clip piece, loop the lanyard through the tether holes on the battery door as shown below.

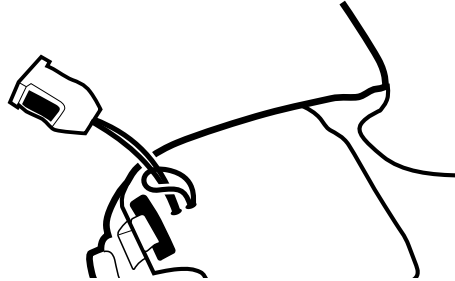

6. Reattach the battery door.

7. Snap the leather strap into the clip.

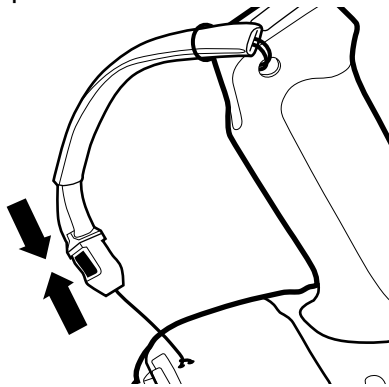

I/O Connector

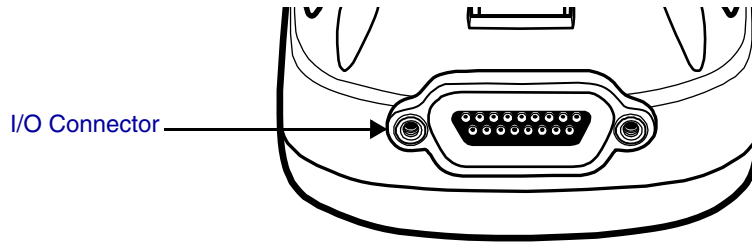

This I/O connector has 17 pins that are designed to work exclusively with Dolphin 7850 peripherals and cables. This connector

- Powers the terminal.
- Charges the main battery.
- Supports communication with a host workstation via Microsoft ActiveSync (see page 7-3).
- Supports RS-232 (up to 115 Kbps) and USB (up to 12 Mbps) communication.

The pins on the I/O connector are as follows:

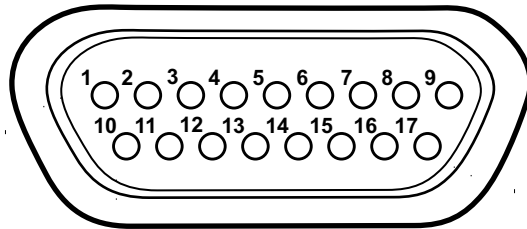

Pin #	Description
1	+USB
2	PWR
3	N/C
4	N/C
5	N/C
6	N/C
7	GND
8	N/C
9	DTR
10	-USB
11	USB DET
12	RI
13	DSR
14	RXD
15	RTS
16	TXD
17	CTS

Note: Signals referenced are for a DTE device.

Rubber Bumpers

There are two sets of rubber bumpers: one set below the scan engine window and the other set on the bottom front of the pistol-grip handle. Rubber bumpers enable you to set the terminal down on a flat surface with easy access to the handle, so you can pick up and put down the terminal with ease.

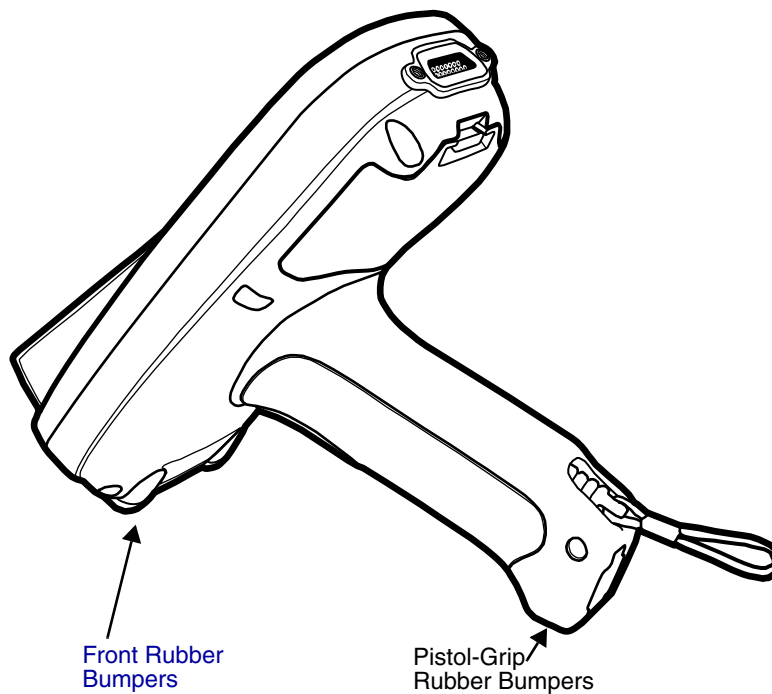

Front Rubber Bumpers

The front rubber bumpers enable you to rest the terminal on a flat surface without damaging the scan engine window.

Battery Power

The intelligent battery technology built into the terminal features two types of battery power:

- The main battery pack installed under the battery door on the back panel.
- The backup battery located inside the terminal.

Both batteries work together to prevent data loss when the terminal is used over long periods of time.

Main Battery Pack



We recommend use of Honeywell Li-Ion battery packs. Use of any non-Honeywell battery may result in damage not covered by the warranty.

CAUTION: There is a risk of explosion if the battery is replaced by an incorrect type of battery. Please refer to the [Guidelines for Battery Pack Use and Disposal](#) (see page 3-14).

The 7.4V, 14.1 watt hour li-ion battery pack is the primary power source for the Dolphin terminal and the internal backup battery. The li-ion battery is designed to operate in a temperature range of -10 to 50°C (14 to 122°F).

Installing the Main Battery Pack

Press Blue + Backlight keys to put the terminal in [Suspend Mode](#) (see page 3-15) before installing a new battery.

Mechanical Switch

The battery well area contains a mechanical switch located under the battery door. When the battery door is securely fastened, it presses on the mechanical switch allowing the terminal to power on and operate normally.

When the battery door is removed, it no longer presses on the mechanical switch, which automatically suspends terminal operation. The terminal will not resume normal operations again until the battery door is re-fastened.

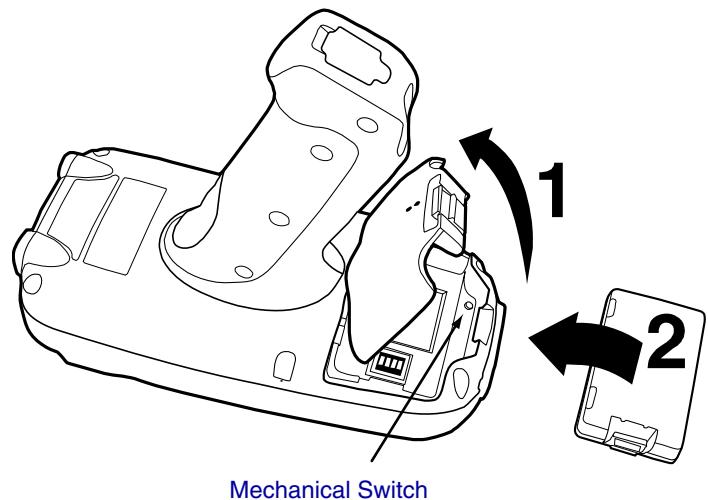

AC Power

The mechanical switch works as described only when the terminal is running on battery power. If the terminal is running on AC power (via Dolphin charging peripheral), the mechanical switch will not suspend the terminal when the battery door is open.

If you open the battery door and remove the battery while the terminal is connected to AC power, the terminal will continue operating. However, if you remove AC power while the battery door is open and the battery is removed, the terminal will shut down without suspending and you will lose RAM data. To avoid data loss when removing AC power, always either suspend the terminal or install the battery prior to removing AC power.

Charging Options

When the battery is installed in the terminal, you can insert the terminal into any one of the following peripherals to charge the main battery pack:

- [Dolphin HomeBase Device](#) (see page 9-1)
- [Dolphin ChargeBase Device](#) (see page 11-1)
- One of the charging cables (see page 12-1)

To fully charge the li-ion battery outside the terminal, use one of the following:

- [Dolphin QuadCharger Device](#) (see page 10-1)
- [Auxiliary Battery Well](#) of the Dolphin HomeBase device

Charge Time

A completely discharged li-ion battery pack requires four(4) hours to charge to full capacity. Subsequent charge times vary according to the charge level of the battery pack when charging begins.

The li-ion battery packs that ship with Dolphin terminals are completely discharged of power. Therefore, charge the main battery pack for a minimum of four(4) hours prior to using the terminal on battery power.

Internal Backup Battery

Located inside the terminal, the backup battery is a 3.6V nickel metal hydride (NiMH) battery.

The internal backup battery prevents the terminal from being reset when you remove the main battery pack. The backup battery retains RAM data and allows the real-time clock to remain operational for up to 30 minutes. If the terminal is left without the main battery pack for more than 30 minutes, the internal backup battery discharges and needs to be recharged to function according to specifications.

Note: Even if the internal backup battery fails, data and programs stored in Flash memory are not totally lost, but the terminal does automatically cold boot when you install a fully charged battery pack and you need to reset the real-time clock.

Charging

The internal backup battery charges off the main battery pack and requires eight(8) hours charge time to backup RAM data for 30 minutes. You can begin using the Dolphin terminal after charging the main battery for four(4) hours; however, the internal backup battery will continue to charge off the main battery.

To ensure that the internal backup battery functions properly, maintain a consistent power supply for the first eight(8) hours of terminal operation. This power supply can be external power (using a charging peripheral) or an installed, charged battery pack or a combination of both.

Guidelines

Follow these guidelines to maximize the life of the terminal's internal backup battery:

- Keep a charged Li-ion battery pack in the terminal.
- Keep the Dolphin terminal connected to a power source when the terminal is not in use.

Managing Battery Power

Data and files saved on the Dolphin terminal may be stored in RAM memory; therefore, maintain a continuous power supply to the terminal to help prevent data loss. When you remove a battery pack, insert another charged battery pack in the Dolphin terminal. If the main battery pack is low, insert the terminal into a charging peripheral to power the terminal and begin recharging the battery.

*Note: If the main battery is low and the terminal is in suspend mode, pressing the SCAN trigger does **not** wake the Dolphin terminal; you must replace the discharged battery with a fully charged battery.*

Default Critical and Low Battery Points

Dolphin terminals are programmed to display warnings when the battery reaches critical and low battery points. The following registry entry sets both warning points:

[HKEY_LOCAL_MACHINE\System\CurrentControlSet\Control\Power]

There are two DWORD values in this registry entry: LowBatt and CriticalBatt. The default values for these entries are as follows:

LowBatt=19 (25%)

This sets the Low Battery point to 25% (19 hex=25 decimal). When the battery hits the percentage charge specified here, the user is notified by this icon in the Navigation bar .

If the main battery is low and the terminal is in suspend mode, pressing the SCAN or Power button won't wake the Dolphin terminal; you **must** replace the discharged battery with a battery charged over 25% mark before you can resume terminal operation.

CriticalBatt=a (10%)

This sets the Critical Battery point to 10% (a hex= 0 decimal). When the battery hits the percentage charge specified here, the user is notified by this icon in the Navigation bar .

Note: Warnings do not appear when the terminal is on external power.

Setting Critical and Low Battery Points

Developers can re-reset the default battery points in the RegEdit Power Tool.

1. Tap **Start > Power Tools > RegEdit**.
2. Drill-down to **HKEY_LOCAL_MACHINE > System > CurrentControlSet > Control > Power**. The CriticalBatt and LowBatt values appear in the list.

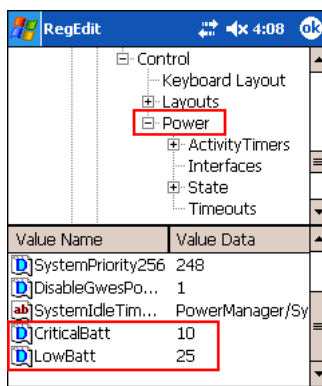

3. Tap the **Value Name** to change the Value Data. You can reset the Value Data from 0 (no warning) to 99 (would warn whenever the charge drops below 99%).
4. Tap **OK** to save changes.

Note: For more information about the RegEdit Power Tool, refer to the Dolphin Power Tools User's Guide, which is available for download at www.honeywell.com/aidc.

Checking Battery Power

Tap **Start** > **Settings** > **System** tab > **Power**.

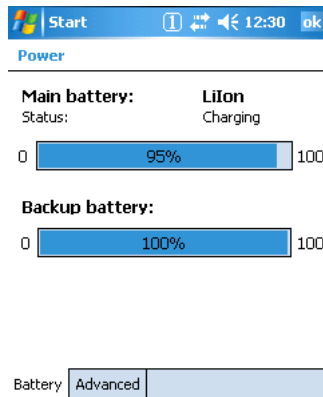

For more information, see [Power](#) on page 6-12.

Storage Guidelines

To maintain optimal battery performance, follow these storage guidelines:

- Avoid storing batteries outside the specified range of -4° to 104° F (-20° to 40°C) or in extremely high humidity.
- For prolonged storage, do not keep batteries stored in a charger that is connected to a power source.

Guidelines for Battery Pack Use and Disposal

The following are general guidelines for the safe use and disposal of batteries:



- We recommend use of Honeywell Li-Ion battery packs. Use of any non-Honeywell battery may pose a personal hazard to the user.
- Replace defective batteries immediately; using a defective battery could damage the Dolphin terminal.
- Never throw a used battery in the trash. It contains heavy metals and should be recycled according to local guidelines.
- Don't use a battery in any other manner outside its intended use in Dolphin terminals and peripherals.
- Don't short-circuit a battery or throw it into a fire; it can explode and cause severe personal injury.
- Excessive discharge damages a battery. Recharge the battery when your terminal indicates low battery power.
- If you observe that the Honeywell battery supplied is physically damaged in some way, please send it to Honeywell International Inc. or an authorized service center for inspection. Refer to the Product Service and Repair section of this guide.
- Although your battery can be recharged many times, it will eventually be depleted. Replace it after the battery is unable to hold an adequate charge.
- If you are not sure the battery or charger is working properly, please send it to Honeywell International or an authorized service center for inspection.

Resetting the Terminal

There are two ways to reset the Dolphin terminal: a soft reset and a hard reset.



Soft Reset (Warm Boot)

A soft reset re-boots the device without losing RAM data. You would perform a soft reset 1) when the terminal fails to respond, 2) after installing software applications that require a reboot, or 3) after making changes to certain system settings.

1. Press and hold the Red  + ESC  keys for approximately five seconds. The screen turns white and the decode and scan LEDs flash for approximately three seconds.
2. When the reset is complete, the Today screen appears.

Hard Reset (Cold Boot)

 *A hard reset erases all of the data and applications stored in RAM memory and launches Autoinstall, which re-initializes the terminal.*

1. Press and hold the Red  + Tab  keys for approximately five seconds. The screen turns white and the decode and scan LEDs light for approximately three seconds.
2. The terminal re-initializes; see [Boot the Terminal](#) on page 2-1.

Note: Hard resets automatically launch a soft reset before ending on the Today screen.

Set the time and date after each hard reset to ensure that the system clock is real-time. Tap the date on the Today screen to open the Clock and set the time and date.





Suspend Mode

Suspend mode suspends terminal operation. The terminal appears to be “off” when in suspend mode.

The terminal is programmed to go into suspend mode automatically when inactive for a specific period of time. You can set this time period in the Power setting. For details, see the **Advanced Tab** section of the [Power](#) (see page 6-12) setting.

To Put the Terminal in Suspend Mode

Press the Blue  + Backlight  keys. You should put the terminal in suspend mode when you change the battery pack; see [Installing the Main Battery Pack](#) on page 3-11.

To Resume Terminal Operation

To resume terminal operation (or “wake” the terminal),

- Press the Backlight key .
- Press the [Scan Trigger](#) (see page 3-6).

Troubleshooting

If the terminal does not wake when you press the scan trigger,

- The battery door may not be fully closed. The mechanical switch under the battery door prevents the terminal from resuming operation until the door is closed.
- The main battery might be too low to resume operation. Remove the battery and install a fully charged battery or connect the terminal to a Dolphin charging peripheral.

Terminal Technical Specifications

Basic Features	
Form Factor:	Purpose-built, compact, handle-style mobile computer
Operating System:	Windows Mobile 5.0
Development Environment:	Honeywell Dolphin SDK for Visual Studio (supports C/C++, C#, and Visual Basic)
Third Party Software:	<ul style="list-style-type: none"> • SOTI MobiControl (remote device management) • PowerNet™ Terminal Emulation (TNVT, 3270, 5250) • ITScriptNet™
CPU:	Intel PXA 270 312 MHz or 520 MHz
Memory (RAM/ROM):	64MB/64MB and 128MB/128 MB options
Display:	3.5 in. 1/4 VGA 240 X 320 TFT color display with hard-coat industrial touch panel
Keyboards:	<ul style="list-style-type: none"> • 24-key calculator-style numeric with scrolling alpha • 38-key calculator-style numeric with full alpha
Communications:	100K duty-cycle plugable/dockable RS232/USB connector, IrDA, Audio beeper
Imager Scanners	
Available Imager Scanners:	<ul style="list-style-type: none"> • 5100SR/SF VGA Area Imagers with bright green LED aimer • 5300SR/SF VGA Area Imagers with High-Vis aiming pattern • 5300HD VGA Area Imagers with High-Vis aiming pattern <p>Caution - use of controls or adjustments or performance of procedures other than those specified herein may result in hazardous radiation exposure.</p>
Available Laser Scanners:	<ul style="list-style-type: none"> • HP (High Performance) Laser scanner • LR (Long Range) Laser scanner • ALR (Advanced Long Range) Laser scanner
1D Symbologies:	Codabar, Code 3 of 9, Code11, Code 32, Pharmaceutical(PARAF), Code 93, Code 128, EAN with Add-On, EAN with Extended Coupon Code, EAN-8, EAN-13, GS1-128, GS1 Databar, Interleaved 2 or 5, ISBT 128, Matrix 2 of 5, MSI, Plessey, PosiCode, Straight 2 of 5 IATA, Straight 2 of 5 Industrial, Telepen, Trioptic Code, UPC, UPC-A, and UPC-E
2D Symbologies:	Aztec, Codablock, Code 16K, Code 49, Composite, Data Matrix, GS1 Databar, MaxiCode, Micro PDF, OCR, PDF417, and QR Code
Composite Codes:	Aztec Mesa, Codablock F, EAN-UCC, GS1 Databar-14
OCR:	OCR-A, OCR-B, OCR-US Money Font
Postal Codes:	Postnet and most international 4 state codes, Australian Post, British Post, Canadian Post, China Post, Japanese Post, KIX (Netherlands) Post, Korea Post, Planet Code

Power	
Battery:	Main: Lithium-ion 7.4V, 14.8 Watt-hour, hot-swappable battery pack Backup: Internal 3.6V nickel metal hydride (NiMH) battery saves RAM data for 30-minutes during main battery change
Run Time (estimated):	WLAN: 10+ hours at 1 scan/6 sec, 1 data package logged every scan, 802.11b/g continuous connection, & display backlight on full
Stand-by Time:	Device suspend mode: 8 days minimum
Charging:	9.5V AC input through handle charge port or USB/Serial connector; four hours recharge
Charging Peripherals:	AC wall adapter, Charge/Communication Cable, single bay Home Base, 4 bay Charge Base, battery Quad Charger
Wireless Radios	
WLAN Standard:	802.11b/g, Wi-Fi Certified
WLAN Security:	WEP, WPA Personal/Enterprise, WPA2 Personal/Enterprise, EAP-TLS, TTLS, LEAP, PEAP, Cisco CCX compliant (pending)
WPAN (optional):	Bluetooth class 2, version 1.2 (optional feature)
Co-Located/Operational:	Two radios: WLAN/WPAN
Physical	
Operating Temperature:	<ul style="list-style-type: none"> Standard configuration is 14°—122°F / -10°—50°C nominal; -4° (-20°C) with reduced runtime Optional Bluetooth configuration is 32°—104°F / 0°—40°C
Construction:	<ul style="list-style-type: none"> Magnesium alloy internal chassis with component shock mounts Engineering-grade polycarbonate outer housing with integrated rubber over-molded handle
Structural:	<ul style="list-style-type: none"> 5 ft. (1.5m) multiple drops to concrete, all axis, across operating temperature range 6 ft. (1.8m) with optional rubber boot cover Exceeds 2000 3 ft. (1m) tumbles
Environmental:	IP64 rated for blown dust/water intrusion
Dimensions:	Main housing: 7.1 in. Long X 3.3 in. Wide X 1.4 in. Deep (18 cm Long X 8.4 cm Wide X 3.6 cm Deep) Handle: 4.6 in. Long X 1.6 in. Wide X 1 in. Deep (12 cm Long X 4.1 cm Wide x 2.5 cm Deep)
Weight:	Approximately 22 oz/684g
Warranty	
Standard:	2 years

Using the Keyboards

Overview

The keyboard buttons are recessed under the overlay for maximum durability. The keyboard panel is backlit for maximum viewability in various lighting conditions. There are two keyboard options:

24-Key Keyboard (see page 4-4)

38-Key Keyboard (see page 4-7)

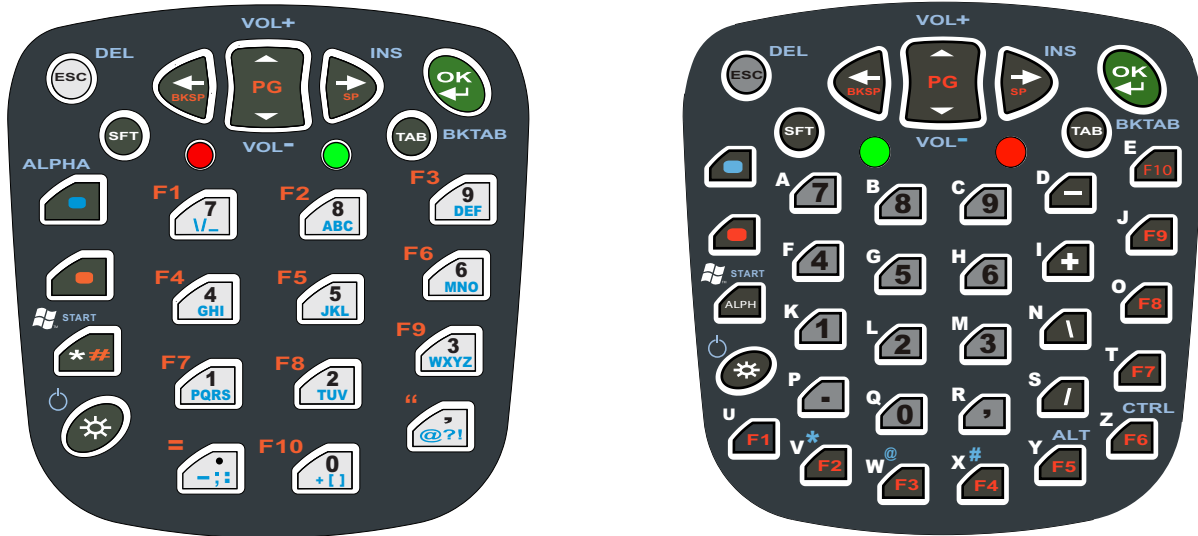

Calculator Style Numbering

Both keyboards default to numeric mode and feature calculator-style numbering.

LEDs

The LEDs in the center of the keyboard work with the on-board imager scanner engine. Both LEDs are user-programmable. Their default behavior is as follows:

Scan LED The LED on the right lights red when you press the Scan trigger in scanning applications.

Decode LED The LED on the left lights green when a scanned bar code is successfully decoded.

For more information, see [Using the Imager Scanner Engine](#) on page 5-1.

Color-Coding

Keyboard overlays are color-coded to indicate the functions performed or characters typed when the color-coded key is pressed with the red or blue modifier key.









Key Types

In addition to the standard number and letter keys, both keyboards contain three types of keys:

1. Function Keys: [Using the Function Keys](#) (see page 4-2)
2. Navigation Keys: [Using the Navigation Keys](#) (see page 4-3)
3. Modifier Keys: [Using the Modifier Keys](#) (see page 4-3)

Using the Function Keys



Function keys perform specific functions and usually have the name of the function they perform.

Name	Key	Function
Backlight		Toggles the keyboard backlight on and off.
Backspace (BKSP)		To backspace, press Red + left arrow. Backspace moves the cursor back one space and deletes each time the key combination is pressed. If you are typing text, a character is deleted each time you backspace.
Backtab (BKTAB)		To backtab, press the Blue + TAB. Backtab moves the cursor back to the previous tab stop or field (on a form or application window).
Delete (DEL)		To delete, press Blue + ESC. Deletes the next character forward. One character is deleted each time the key combination is pressed.
Escape		Cancels an action.
OK		Functions as an Enter key.
Resume		Resume the terminal by pressing Blue + Backlight. <i>Note: You can also press the Scan trigger on the handle.</i>
Space (SP)		To space, press Red + right arrow. Space moves the cursor one space forward. If you are typing text, it moves the text one space forward as well.
Tab		Moves the cursor to the next tab stop or field (on a form or application window).

Note: There is no SCAN key on the Dolphin 7850 terminal keyboard; scanning is initiated with the [Scan Trigger](#) (page 3-6).

Using the Navigation Keys

Located in the center of each keyboard for easy access with either hand, the navigation keys enable you to navigate the cursor through an application screen.



Press	To ...
	Move the cursor up one row or line. Move the cursor down one row or line.
	Move the cursor one character to the right.
	Move the cursor one character to the left.

The navigation keys perform additional system functions when pressed in combination with the Blue and Red modifier keys. For details, see the key combination tables for the [24-Key Keyboard](#) (page 4-4) and the [38-Key Keyboard](#) (page 4-7).

Additional functionality of the navigation keys varies according to the application in use.



Using the Modifier Keys

Modifier keys modify the next key pressed to perform functions or type special characters. The keyboards are color-coded to match the Blue and Red modifier keys.

Name	Key	Function
Shift		Provides shift functionality for application windows. Tap once to modify the next letter pressed. Tap twice for caps lock.
Blue & Red		Modifies the next key pressed. The overlay of each keyboard is color-coded to indicate the character typed or function performed with both keys.
Alpha		On the 38-key keyboard, the Alpha key toggles the keyboard between alpha and numeric modes.

Keyboard Mode Indicator

Dolphin terminals have a Keyboard Status Power Tool (**Start > Power Tools > Keyboard Status**) that displays an icon in the Navigation bar to indicate if the keyboard is in alpha or number mode. Keyboard Status is active by default.

-  Indicates that the keyboard is in numeric mode.
-  Indicates that the keyboard is in alpha mode, uppercase.
-  Indicates that the keyboard is in alpha mode, lowercase.

24-Key Keyboard

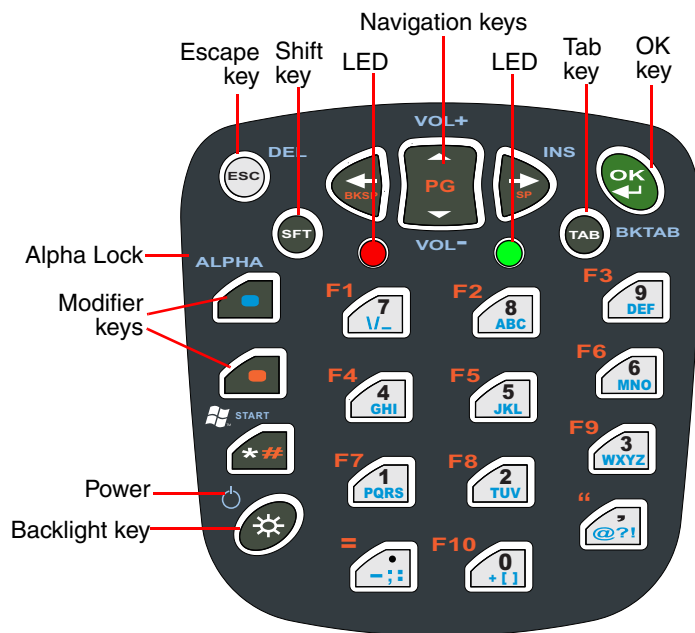

Toggleing Between Alpha and Numeric Modes

The 24-key keyboard defaults to numeric mode. Numeric mode is when you type numbers with the number keys.

- Double-tap the Blue modifier key to toggle between alpha and numeric modes.
- Single-tap the Blue modifier key to toggle to alpha or numeric mode only for the next key pressed. The keyboard returns to the previous state before the next key pressed.
- Press and hold the Blue modifier key to toggle to alpha or numeric mode for all keys pressed until the Blue modifier key is released.

Alpha Mode

Alpha mode is when you type the letters or characters indicated in blue on the number keys.

Please note that when typing in alpha mode, you must use the same multi-press method you would use when typing letters on a phone keypad. Each key press types the next letter in the sequence as displayed by the alpha indicator.

You can still use the Blue modifier key for regular Blue key combinations in alpha mode; just press the Blue modifier key and the next key. For combinations, see [38-Key Keyboard](#) on page 4-7.

Shift Functionality in Alpha Mode

The SFT key performs all the normal windows shift key functions alpha mode, including capitalizing one letter. On the 24-key keyboard, the SFT key also toggles caps lock on and off.

- Single-tap the SFT key to modify the next key pressed; if this is a letter, that letter is capitalized.
- Double-tap the SFT key to toggle caps lock on and off in alpha mode.

Note: Check the mode indicator (see [Keyboard Mode Indicator](#) on page 4-3) in the Navigation bar to see what mode the keyboard is in.

24-Key Keyboard Numeric Key Combinations

Key	Blue Mode	Num Mode	Num Shift
ESC	Delete	ESC	ESC
SFT	*Toggle Upper/Lower/Shift	*Toggle Upper/Lower/Shift	*Toggle Upper/Lower/Shift
Blue	***Toggle Num/Alpha	Blue Mode	***Toggle Num/Alpha
Red	Red Mode; see 24-Key Keyboard Alpha Key Combinations on page 4-6.		
Asterisk	Start menu	*	*
Light	Suspend	Keyboard Light	Keyboard Light
Left		Left	Left
Up	Volume up	Up	Up
Down	Volume down	Down	Down
Right	Insert	Right	Right
OK	OK	OK	OK
Tab	Backtab	Tab	Tab
Period	- ; :	.	>
Comma	@ ? !	,	<
0	+ []	0)
1	pqrs or PQRS	1	!
2	tuv or TUV	2	@
3	wxyz or WXYZ	3	#
4	ghi or GHI	4	\$
5	jkl or JKL	5	%
6	mno or MNO	6	^
7	/ \ _	7	&
8	abc or ABC	8	*
9	def or DEF	9	(

*Toggles uppercase and lowercase only on a double-tap.

**Single-tap SFT changes the mode for only the next character. Double-tap SFT key to change mode for all keys pressed after.

***Toggles numeric and alpha modes only on a double-tap.

24-Key Keyboard Alpha Key Combinations

Key	Red Mode	Alpha Base	Alpha Shift	Alpha Caplock	Alpha Shift Caplock
ESC	ESC	ESC	ESC	ESC	ESC
SFT	*Toggle Upper/ Lower/Shift	*Toggle Upper/ Lower/Shift	*Toggle Upper/ Lower/Shift	*Toggle Upper/ Lower/Shift	*Toggle Upper/Lower/ Shift
Blue		***Toggle Num/ Alpha	***Toggle Num/ Alpha	***Toggle Num/ Alpha	***Toggle Num/Alpha
Red		Red Mode	Red Mode	Red Mode	Red Mode
Asterisk	#	*	*	*	*
Light	Keyboard Light	Keyboard Light	Keyboard Light	Keyboard Light	Keyboard Light
Left	Backspace	Left	Left	Left	Left
Up	Page Up	Up	Up	Up	Up
Down	Page Down	Down	Down	Down	Down
Right	Space	Right	Right	Right	Right
OK	OK	OK	OK	OK	OK
Tab		Tab	Tab	Tab	Tab
Period	=	- ; :	- ; :	- ; :	- ; :
Comma	“	@ ? !	@ ? !	@ ? !	@ ? !
0	F10	+ []	+ { }	+ []	+ { }
1	F7	pqrs	PQRS	PQRS	pqrs
2	F8	tuv	TUV	TUV	tuv
3	F9	wxyz	WXYZ	WXYZ	wxyz
4	F4	ghi	GHI	GHI	ghi
5	F5	jkl	JKL	JKL	jkl
6	F6	mno	MNO	MNO	mno
7	F1	/ \ _	{ } _	/ \ _	{ } _
8	F2	abc	ABC	ABC	abc
9	F3	def	DEF	DEF	def

*Toggles uppercase and lowercase only on a double-tap.

**Single-tap SFT changes the mode for only the next character. Double-tap SFT key to change mode for all keys pressed after.

***Toggles numeric and alpha modes only on a double-tap.

38-Key Keyboard

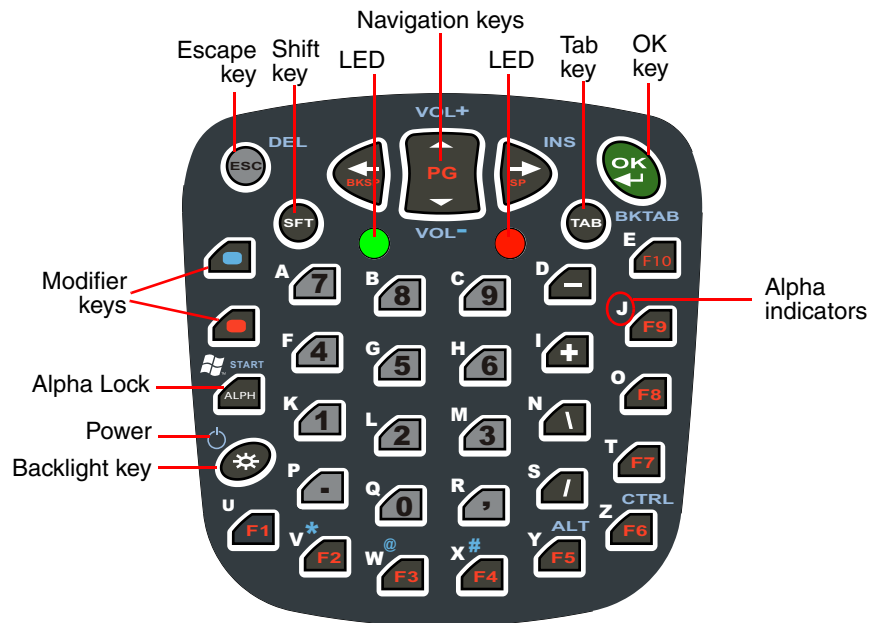

Toggleing Between Numeric and Alpha Modes

The 38-key keyboard defaults to numeric mode. Numeric mode is when you type numbers with the number keys. Alpha mode is when you type the letter indicated on the overlay when you press the number key.

Alpha Mode

Single-tap the ALPH key  to toggle to alpha or numeric mode only for the next key pressed.

Shift Functionality in Alpha Mode

The SFT key performs all the normal windows shift key functions in alpha mode, including capitalizing one letter. On the 38-key keyboard, the SFT key also toggles caps lock on and off.

- Single-tap the SFT key to modify the next key pressed; if this is a letter, that letter is capitalized.
- Double-tap the SFT key to toggle caps lock on and off in alpha mode.

Note: Check the mode indicator (see [Keyboard Mode Indicator](#) on page 4-3) in the Navigation bar to see what mode the keyboard is in.

ALT & CTRL Functionality

The 38-key keyboard contains ALT and CTRL functionality via a Blue-key combination.

ALT: Blue + F5

CTRL: Blue + F6

38-Key Keyboard Alpha Key Combinations

Key	Blue Mode	Alpha Base	Alpha Shift	Alpha Caplock	Alpha Shift Caplock
ESC	Delete	ESC	ESC	ESC	ESC
SFT	*Toggle Upper/ Lower/Shift	*Toggle Upper/ Lower/Shift	*Toggle Upper/ Lower/Shift	*Toggle Upper/ Lower/Shift	*Toggle Upper/Lower/ Shift
Blue		Blue Mode	Blue Mode	Blue Mode	Blue Mode
Red		Red Mode	Red Mode	Red Mode	Red Mode
ALPH	Start	Num Mode	Num Mode	Num Mode	Num Mode
Light	Suspend	Keyboard Light	Keyboard Light	Keyboard Light	Keyboard Light
Left		Left	Left	Left	Left
Up	Volume up	Up	Up	Up	Up
Down	Volume down	Down	Down	Down	Down
Right	Insert	Right	Right	Right	Right
OK	OK	OK	OK	OK	OK
Tab	Backtab	Tab	Tab	Tab	Tab
Period		p	P	P	p
Comma		r	R	R	r
0		q	Q	Q	q
1		k	K	K	k
2		l	L	L	l
3		m	M	M	m
4		f	F	F	f
5		g	G	G	g
6		h	H	H	h
7		a	A	A	a
8		b	B	B	b
9		c	C	C	c
-		d	D	D	d
+		i	I	I	i

38-Key Keyboard Alpha Key Combinations

Key	Blue Mode	Alpha Base	Alpha Shift	Alpha Caplock	Alpha Shift Caplock
\		n	N	N	n
/		s	S	S	s
F1		u	U	U	u
F2	*	v	V	V	v
F3	@	w	W	W	w
F4	#	x	X	X	x
F5		y	Y	Y	y
F6		z	Z	Z	z
F7		t	T	T	t
F8		o	O	O	o
F9		j	J	J	j
F10		e	E	E	e

*Toggle Upper/Lower only on a double-tap.

**Single-tap of SFT key changes shift mode for just the next character. Double-tap of SFT key toggles Caplock.

***Single tap of BLUE key changes mode for just the next character. Double tap toggles Num/Alpha.

38-Key Keyboard Numeric Key Combinations

Key	Blue Mode	Num Mode	Num Shift
ESC	Delete	ESC	ESC
SFT	*Toggle Upper/Lower/Shift	*Toggle Upper/Lower/Shift	*Toggle Upper/Lower/Shift
Blue		Blue Mode	Blue Mode
Red		Red Mode	Red Mode
ALPH	Start	Alpha Mode	Alpha Mode
Light	Suspend	Keyboard Light	Keyboard Light
Left		Left	Left
Up	Volume up	Up	Up
Down	Volume down	Down	Down
Right	Insert	Right	Right
OK	OK	OK	OK
Tab	Backtab	Tab	Tab
Period		.	>
Comma		"	<
0		0)
1		1	!
2		2	@
3		3	#
4		4	\$
5		5	%
6		6	^
7		7	&
8		8	*
9		9	(
-		-	-
+		+	+

38-Key Keyboard Numeric Key Combinations

Key	Blue Mode	Num Mode	Num Shift
\		\	}
/		/	{
F1		F1	F1
F2	*	F2	F2
F3	@	F3	F3
F4	#	F4	F4
F5		F5	F5
F6		F6	F6
F7		F7	F7
F8		F8	F8
F9		F9	F9
F10		F19	F10

*Toggle Upper/Lower only on a double-tap.



Using the Imager Scanner Engine

Overview

The compact imager scanner engine uses Adaptus® Imaging Technology 5.0, which instantly reads all popular 1D and 2D bar codes and supports omni-directional aiming and decoding. This engine can also capture digital images, such as signatures and pictures of damaged inventory.

Available Engines

5100 Standard Range (5100SR)

5300 Standard Range (5300SR)

	8.3 mil Linear	10 mil PDF417	13 mil UPC	15 mil Data Matrix	15 mil QR	35 mil MaxiCode
Working Range:	(.020 cm)	(.025 cm)	(.033 cm)	(.038 cm)	(.038 cm)	(.089 cm)
Near	3.5 in. (8.9 cm)	3.1 in. (7.9 cm)	2.1 in. (5.3 cm)	2.3 in. (5.8 cm)	3.1 in. (7.9 cm)	2.0 in. (5.1 cm)
Far	7.6 in. (19.3 cm)	9 in. (22.9 cm)	13.2 in. (33.5 cm)	10.2 in. (25.9 cm)	8.8 in. (22.4 cm)	13.0 in. (33 cm)

5100 Smart Focus (5100SF)

5300 Smart Focus (5300SF)

	6.6 mil PDF417	7.5 mil Linear	10 mil Linear	10 mil PDF417	13 mil UPC	15 mil Data Matrix
Working Range:	(.017 cm)	(.019 cm)	(.025 cm)	(.025 cm)	(.033 cm)	(.038 cm)
Near	2.7 in. (6.8 cm)	2.4 in. (6.1 cm)	2.1 in. (5.3 cm)	2.1 in. (5.3 cm)	1.9 in. (4.8 cm)	1.7 in. (4.3 cm)
Far	5.9 in. (14.9 cm)	6.4 in. (16.2 cm)	7.5 in. (19 cm)	7.5 in. (19 cm)	8.8 in. (22.3 cm)	7.4 in. (18.8 cm)

Available Laser Engines

High Performance (HP)

	5 mil	55 mil reflective
Working Range:		
Near	2.75 in (0.07 m)	5 in (0.13 m)
Far	7 in (0.17 m)	66 in (1.7 m)

Long Range (LR)

	10 mil	100 mil reflective
Working Range:		
Near	11 in (0.28 m)	60 in (1.5 m)
Far	24 in (0.6 m)	240 in (6.1 m)

Advanced Long Range (ALR)

	13 mil	100 mil reflective
Working Range:		
Near	19 in (0.48 m)	125 in (3.2 m)
Far	39 in (1 m)	360 in (9.1 m)

Laser Specifications

The maximum power outputs for each diode are as follows:

- Illumination LED: 194.0 uW
- Aimer laser (5300 engine): 360.1 uW
- Aimer LED (5100 engine): 81.6 uW

Supported Bar Code Symbologies

Symbology Type	Symbology Name
1D Symbologies	Codabar Code 3 of 9 Code 11 Code 32 Pharmaceutical (PARAF) Code 93 Code 128 EAN with Add-On EAN with Extended Coupon Code EAN-8 EAN-13 GS1-128 GS1 Databar Interleaved 2 or 5 ISBT 128 Matrix 2 of 5 MSI Plessey PosiCode Straight 2 of 5 IATA Straight 2 of 5 Industrial Telepen Trioptic Code UPC UPC-A UPC-E
2D Symbologies	Aztec Codablock Code 16K Code 49 Composite Data Matrix GS1 Databar MaxiCode Micro PDF OCR PDF417 QR Code
Composite Codes	Aztec Mesa Codablock F EAN-UCC GS1 Databar-14
OCR	OCR US Money Font MICR (E 13 B) and SEMI Font OCR-A OCR-B
Postal Codes	Postnet and most international 4-state codes Australian Post British Post Canadian Post China Post Japanese Post KIX (Netherlands) Post Korea Post Planet Code

Activating the Engine

The scan trigger on the front of the integrated pistol-grip handle that activates the scan engine.

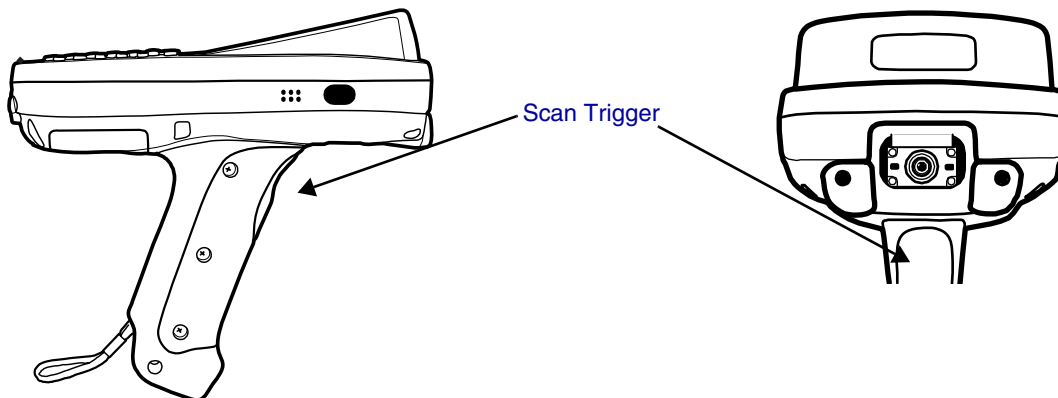

Using Demos

Demos are software utilities loaded on all Dolphin terminals that demonstrate the advanced features of the terminal. Two Demos feature the scan engine: Image Demo and Scan Demo.

To access these demos, tap **Start > Demos**,

- Select **Image Demo** to verify imaging, or
- Select **Scan Demo** to verify decoding.

For more information about Demos, refer to the Dolphin Demos User's Guide, which is available for download from www.honeywell.com/aidc.

LEDs

The LEDs in the center of both keyboards (for location, see [LEDs](#) on page 4-1) light when using the scan engine.

- | | |
|-------------------|---|
| Scan LED | The LED on the right lights red when you press the scan trigger in scanning applications. |
| Decode LED | The LED on the left lights green when a scanned bar code is successfully decoded. |

Decoding

The Dolphin terminal supports two types of image decoding: full-area imaging and Advanced Linear Decoding (ALD).

Full-area Imaging

Full-area imaging means that the Dolphin terminal support omni-directional aiming, which means that a positive read can be obtained from many positions. For details, see [Omni-Directional Scanning Positions](#) on page 5-4.

ALD

ALD provides fast reading of linear (1D) and stacked linear bar codes (e.g., PDF417). For the best read, the aiming pattern should be centered horizontally across the bar code. When ALD is enabled, the reader does not read matrix or postal codes.

To Decode a Bar Code

1. Tap **Start > Demos > Scan Demo**.
2. Position the Dolphin terminal over one of the sample bar codes on page 5-5. A range of 4–10 inches (10–25 cm) from the bar code is recommended.
3. Project the aiming pattern by pressing and holding the Scan trigger. The Scan LED lights red.
4. Center the aiming beam over the bar code. The aiming beam should be oriented in line with the bar code to achieve optimal decoding; see [Omni-Directional Scanning](#) on page 5-6.
5. Release the Scan trigger.
6. When the bar code is successfully decoded, the decode LED lights green and the terminal beeps.

Sample Bar Codes

You can use the following bar codes to verify decoding:

Sample 128



Code 128

Sample PDF417



PDF417 Test Message

Omni-Directional Scanning

Dolphin terminals support omni-directional scanning.

In general, the aiming pattern or beam is smaller when the terminal is held closer to the bar code and larger when farther from the bar code. Symbologies with smaller bars or elements (mil size) should be read closer to the terminal whereas larger bars or elements (mil size) should be read farther from the terminal.

Note: To achieve the best read, the aiming beam should be centered horizontally across the bar code.

5300 High-Vis Aiming Pattern

The red high-vis aiming pattern frames the bar code.

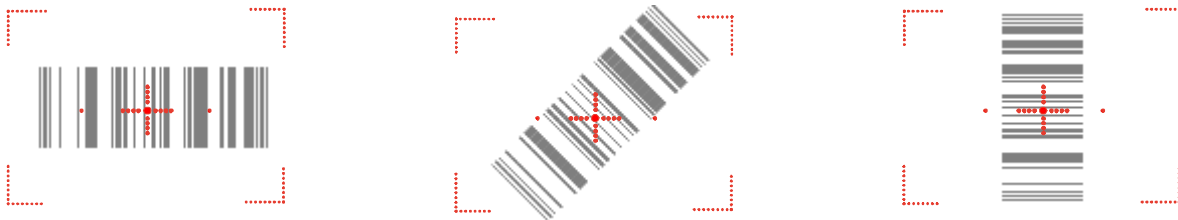

5100 Green Aiming Beam

The green aiming beam projects outward in a straight line across the bar code.



Laser Engines (HP, LR, and ALR)

Laser engines do **not** support omni-directional scanning.

To achieve a successful scan, the red beam must completely cover the bar code as in the following example:



To avoid specular reflection when scanning (i.e., the glare), do not aim the laser so that the beam is reflected straight back. Instead, aim the laser so that it's slightly off-center of the target bar code.

Capturing Images

The image-capture process is an intuitive, split-second operation for experienced users. By following basic guidelines, however, new users can easily develop their own technique and, with practice, quickly learn to adapt to different application environments.

Image Preview

When the imaging process is initiated, the screen displays a preview of the object. This is a live video image of what the imager is currently viewing and has a slightly degraded appearance compared to the captured image. This slight degradation is normal; the captured image has a higher resolution.

File Formats

The Dolphin terminal is capable of saving images in a number of industry-standard file formats such as BMP, JPG and PNG. The default file format for images is a grayscale JPG. To obtain the highest quality images, take grayscale images.

File Size

Digital images have a maximum image size of 640 x 480 pixels and an image definition up to a 256 grayscale. The image quality and related file size are determined by the data compression method used by the software application used to take the image. The average size of the image file is approximately 4–8K. However, the size of the image depends on image content; the more complex the content, the larger the file size.

Taking an Image

1. Tap **Start > Demos > Image Demo**.
2. Point the Dolphin terminal at the object.
3. Press the scan trigger to activate the engine. The screen displays a preview of the object.
4. Adjust the Dolphin terminal's position until the preview on the screen appears as you want it to appear in the image.
5. Hold the Dolphin terminal still and release the Scan trigger. The screen flashes and the captured image appears on the screen.
6. By default, the image is saved to the My Device folder (**Start > Programs > File Explorer > My Device**). To save the image to another location, tap **File > Save As**.

High-Vis Aiming Pattern

If your Dolphin terminal is configured with an 5300 imager, you can enable the aiming pattern for imaging in the Image Demo application. For details about the aiming pattern, see [Omni-Directional Scanning](#) on page 5-6.

1. Tap **Start > Demos > Imaging Demo > Options** menu > **Aimer**.
2. The aiming pattern is now enabled for imaging.

Uploading Images

Image files can be transmitted to a host workstation via

- Microsoft ActiveSync and a Dolphin communication peripheral, or
- Over your wireless radio network.



Overview

Customizable settings are available from the Start menu. Tap **Start > Settings** and the Settings screen opens displaying the Personal tab. Settings consists of three tabs: Personal, System, and Connections.

Personal Tab

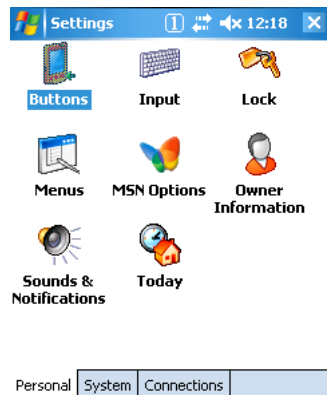

System Tab

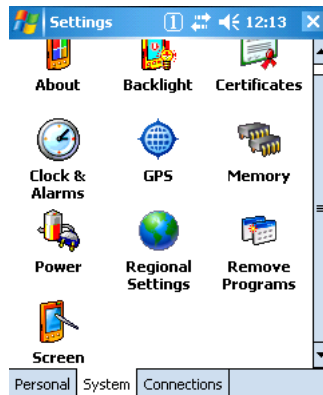

Connections Tab

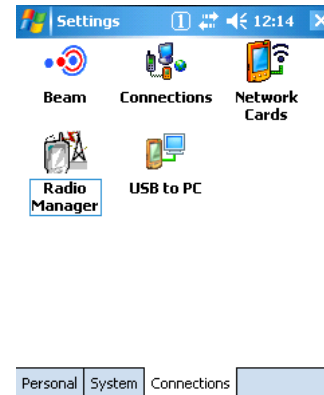

Tab	Description
Personal	The Personal tab provides access to personal configuration programs. For details, see Personal Settings on page 6-2.
System	The Systems tab provides action to programs that monitor and adjust major system functions. For details, see System Settings on page 6-7.
Connections	The Connections tab provides access to most of the terminal's communication options. For details, see the Connections Tab (see page 7-6) in the Communication chapter.

Personal Settings

To access the Personal tab, go to **Start > Settings**. The screen opens displaying the Personal tab.



Icon	Description	See Page
Buttons	Programs hardware buttons to launch applications or execute commands.	6-3
Input	Customizes the SIP. For details.	6-4
Lock	Provides password protection for certain programs on the terminal.	N/A
Menus	Customizes what appears on the Start and New menus.	6-5
Owner Information	Stores your contact information. This information will appear on the Today screen.	N/A
Sounds & Notifications	Sets the sound volume, enables and disables sounds for specific actions, and sets sound parameters for system notifications.	N/A
Today	Customizes the look and the information displayed on the Today screen.	N/A

Note: Personal settings are stored in RAM memory and are replaced by system defaults after each hard reset. For more information about resets, see [Resetting the Terminal](#) on page 3-15.

Buttons

The Buttons setting programs keyboard buttons to launch applications or execute commands. The default button assignments that appear on the Buttons window are inactive until you enable the HotKeys Power Tool.

You must enable the HotKeys Power Tool to activate the button assignments in the Buttons setting.

1. Tap **Start > Power Tools**.

2. Tap the **HotKeys** icon **once**  HotKeys.
3. HotKeys is enabled and the button assignments in the Buttons setting are active.
4. Verify the button assignment by tapping the button on the keyboard.

For more information about HotKeys, refer to the Dolphin Power Tools User's Guide, which is available for download from www.honeywell.com/aidc.

Changing Button Assignments

1. After HotKeys is enabled, tap **Start > Settings > Personal tab > Buttons**.

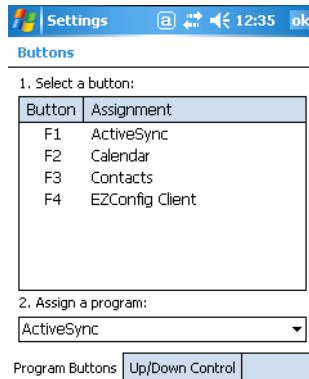

Note: The buttons that appear on this window are the only buttons that can be programmed via the Buttons setting. You cannot add hardware buttons to this window.

2. Tap on the name of the application in the **Assignment** column and select a program or command in the **Assign a program** drop down list.
3. Tap **OK** to save.

Available Programs

The **Assign a program** list contains the applications installed on the terminal. If there is a program installed that you would like to see in this list, paste a Shortcut to the program in the **\\Windows\Start Menu\Programs** folder.

For instructions about creating shortcuts, see [Using File Explorer](#) on page 6-5.

Commands

The **Assign a program** list also contains the following commands:

Command	Description
<Input Panel>	Opens the soft input panel.
<None>	Nothing happens when the button is pressed.
<OK/Close>	Performs the same function as tapping OK on the screen.
<Scroll Down>	Scrolls down in the open application.
<Scroll Left>	Scrolls left in the open application.
<Scroll Right>	Scrolls right in the open application.
<Scroll Up>	Scrolls up in the open application.
<Start Menu>	Opens the Start menu.
<Today>	Opens the Today screen.

Input Panel Options

You can set input options by going to **Start > Settings > Personal tab > Input**. The following graphics are the tab windows where you can customize the SIP (Soft Input Panel) to your preferences:

Input tab

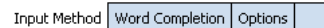
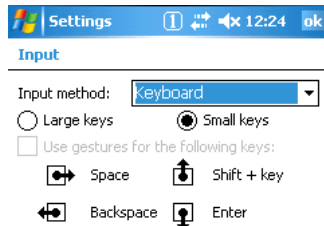

Word Completion tab

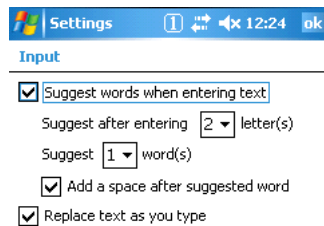

Options tab

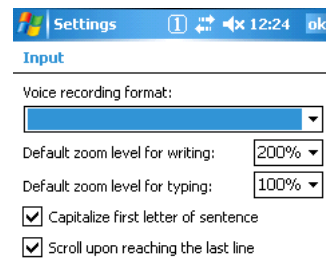

Menus - Modifying the Start Menu

You can add existing programs you use often, such as File Explorer, to the Start menu for faster access. You are not installing the program, just enabling the user to access the program from the Start menu.

You can add a program to the Start Menu three ways: directly by using the Menus setting, or creating and pasting shortcuts in File Explorer on the terminal or the workstation (and using ActiveSync to transfer to the shortcut to the terminal).

Note: Only seven applications total are allowed on the Start menu.

Using the Menu System Setting

1. Tap **Start > Settings > Personal** tab > **Menus > Start Menu** tab.

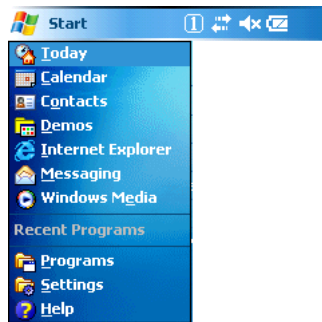

2. Tap the check box for the program you want to add and tap **OK** to save.
3. Tap the **Start** menu to verify that the program appears on it.

Using File Explorer

If you do not see the program listed, you can either use File Explorer to move the program or ActiveSync on the desktop computer to create a shortcut to the program and place the shortcut in the Start Menu folder.

Note: We recommend that you Copy and Paste Shortcut so that you do not alter your program configurations by accident. Using Copy and Paste Shortcut (as opposed to Cut/Copy and Paste) ensures that the program files remain where they need to be for the system to find them to perform system functions.

1. Tap **Start > Programs > File Explorer**, and navigate to the program. File Explorer opens to My Documents by default; to see a list of all folders, tap the folder name and then **My Device**.

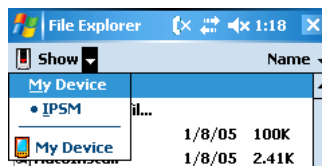

2. In File Explorer, navigate to the \Program Files folder. Tap and hold on a program, then select **Copy** on the pop-up menu.

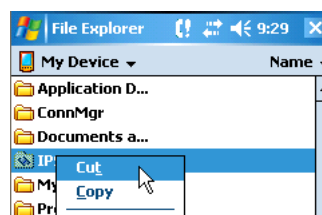

-
3. Navigate to the Windows folder and open the Start Menu folder (My Device > Windows > Start Menu), tap and hold a blank area of the window, and tap **Paste Shortcut** on the pop-up menu.

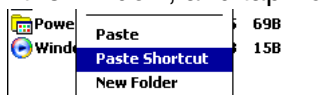

4. The shortcut is now in the folder.

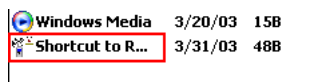

5. Tap the **Start** menu to verify that the program now appears on it.

Using Windows Explorer

Here, you are performing the same basic process as on the terminal, except that you are using the Explore utility in ActiveSync (Windows Explorer) to copy and paste the shortcut from the workstation to the terminal. For more details using Explore in ActiveSync, see [Exploring the Terminal from the Workstation](#) on page 7-4.

1. Using a Dolphin peripheral, connect the terminal to the workstation via ActiveSync.
2. On the workstation, when ActiveSync opens after connecting, tap **Explore**. Windows Explorer opens to the files on the terminal.
3. Navigate to the program.
4. Right-click on the program and select **Create Shortcut**.
5. Select the shortcut, right-click, and select **Cut**.
6. Navigate to the **Start Menu** folder (\Windows\Start Menu).
7. Right-click on an empty area and select **Paste Shortcut**.
8. On the terminal, tap the **Start** menu and verify that program appears.

System Settings

The System tab enables you to verify and sometimes alter system parameters.

To access the System tab, go to **Start > Settings > System** tab.

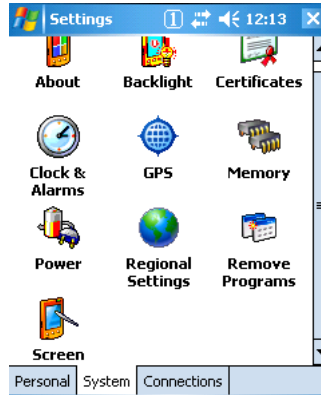

- [About](#) (see page 6-7)
- [Backlight](#) (see page 6-8)
- [Certificates](#) (see page 6-9)
- [Clock & Alarms](#) (see page 6-9)
- [GPS Settings](#) (see page 6-9)
- [Memory](#) (see page 6-10)
- [Power](#) (see page 6-12)
- [Remove Programs](#) (see page 6-14)
- [Regional Settings](#) (see page 6-13)
- [Screen](#) (see page 6-15)

About

The About system setting displays specific information about what is loaded on the terminal on three tab windows:

Tab	Description
Version Tab	Displays the information about the software, operating system, and processor of the terminal. The processor for the Dolphin 7850 terminal is an Intel XScale PXA 270 520MHz processor.
Device ID Tab	Displays the information the terminal uses to identify itself to other devices. It is important to know this information to identify the terminal when connecting to the network. Device name: Displays the system's default name. This is the name used by ActiveSync. Description: Displays the description of the device ID.
Copyrights Tab	Displays important copyright information.

Backlight

The backlight for the color display is user-defined.

Tap **Start** > **Settings** > **System** tab > **Backlight**. There are two tabs: **Battery** and **External**; the options on each tab are the same.

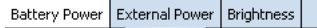
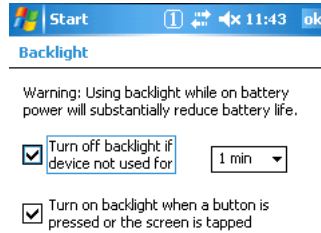

The **Battery** tab determines display backlight settings when the terminal is running on battery power. The **External** tab determines display backlight settings when the terminal is powered by an external source, such as a charge cable.

Brightness Tab

The **Brightness** tab determines the brightness of the display backlight when it's on.

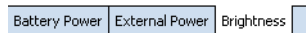
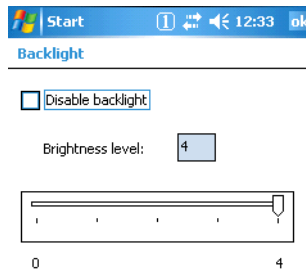

To disable the backlight, check **Disable backlight**. Tap **OK** to save all changes.

Certificates

Certificates shows you the network certificates recognized by the operating system. There are personal and root certificates; each has its own tab.

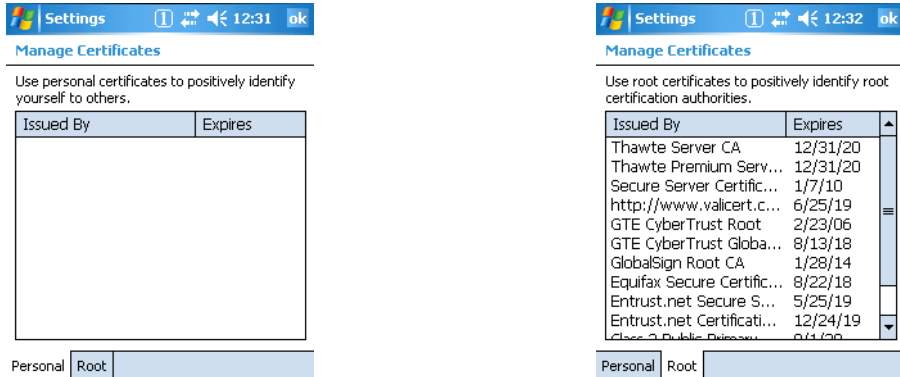

It is important to verify that the operating system acknowledges your certificate. If the certificate does not appear on one of these tabs, the operating system does not see it, and it will not function properly during the network authentication process.

For more information, see [Certificates](#) on page 8-12.

Clock & Alarms

Clock & Alarms sets the system clock. Appointments, scheduled events, and any function on a schedule runs off this setting. You need to set the time and date after each hard reset. You can also access this setting by tapping the date on the Today screen.

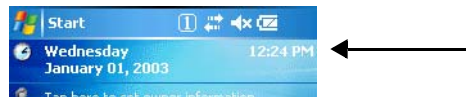

GPS Settings

GPS Settings is a Microsoft GPS tool.

Memory

Dolphin terminals have two types of memory: volatile and non-volatile. Each type of memory has its own options.

Volatile

Data stored in volatile memory does not persist through cold boots; see [Hard Reset \(Cold Boot\)](#) on page 3-15. Volatile memory is used for running and storing programs as well as storing program data and is also known as RAM memory. The Dolphin 7850 terminal can have 64MB or 128MB of volatile memory depending on your configuration.

Non-Volatile

Data stored in non-volatile Flash memory *does* persist through cold boots. The Dolphin 7850 terminal can have 64MB or 128MB of non-volatile memory depending on your configuration.

IPSM: (Internal Persistent Storage Manager) is the on-board Flash memory. Because this memory is non-volatile, data and programs stored in IPSM are not affected when power is removed or a cold boot launched. For this reason, default programs and files for Dolphin terminals such as Autoinstall are stored in IPSM.

Storage Card: The other type of non-volatile memory is a factory-installed Secure Digital (SD) memory card. You can add up to 4GB of additional memory on non-RF units only. This card is not user-accessible.

If you need to reformat the card, there is an EZFormat Power Tool on 7850s with a storage card installed. For more details about EZFormat, refer to the Dolphin Power Tools User's Guide, which is available for download from www.honeywell.com/aidc.

Use the Memory system setting to check memory usage after you receive warning messages about memory. There are three tabs: Main, Storage Card, and Running Programs.

Main Tab

This tab displays current capacity and usage of the 64MB or 128MB of on-board, volatile memory.

Storage	Program
Total: 20.40 MB	Total: 116.43 MB
In use: 13.02 MB	In use: 15.13 MB
Free: 7.38 MB	Free: 101.30 MB

Field	Description
Columns	Storage: The part of RAM memory used for storing programs and program data. Program: The part of RAM memory used to run programs.
Total	Displays the current MB of memory allocated for Storage and Program use.

Field	Description
In use	Displays the total MB of that allocated memory being used in Storage and Program memory functions.
Free	Displays the total MB of memory available for Storage and Programs use.

Storage Card Tab

This tab displays the current capacity and usage statistics of the selected memory type: IPSM or Storage Card. Select the memory type from the drop-down list. **IPSM** is selected by default.

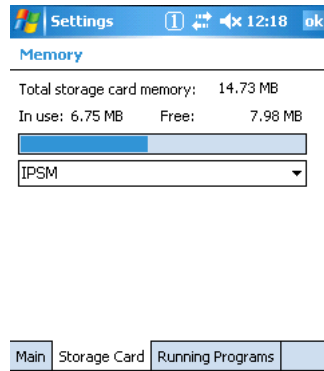

Field	Description
Total storage card...	The total MB of memory capacity of the selected memory.
In use	The MB currently being used.
Free	The MB that is still available for use.
Drop-down list	IPSM —When IPSM is selected in the drop-down list, the Storage Card tab displays the IPSM memory capacity and usage statistics.

Running Programs Tab

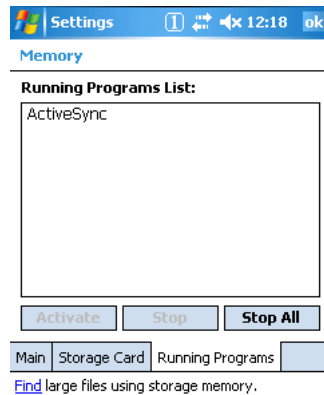

This tab displays the running software programs using storage memory. Check this tab when you are receiving out of memory errors or when the mobile computer is running slowly. Select a program in the list and tap **Stop** to stop it from running (and therefore from using memory). Tap **Stop All** to automatically stop all running programs.



Anytime you stop a running program, it frees up volatile memory. Be advised that, when you stop a program here, any unsaved data in that program is lost. To free up memory without risking data loss, return to the running program, save your data, and close the application.

Find Link

Find searches for large files using storage memory. Clicking Find opens the Search program with **Larger than 64KB** already selected in the **Type** field. Enter the search criteria and tap **Search**.

Power

Battery Tab

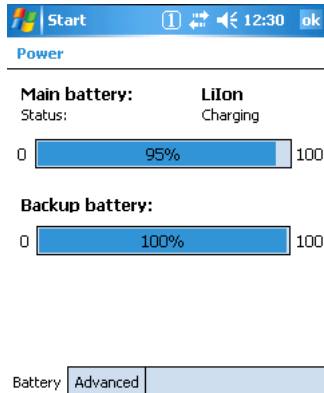

For more information about the terminal's batteries, see [Battery Power](#) on page 3-11.

Advanced Tab

Determines the amount of time that elapses before the terminal automatically goes into suspend mode; see [Suspend Mode](#) on page 3-15. You have the option of selecting time periods for both battery and external power.

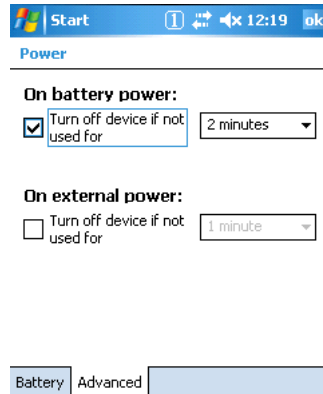

Field	Description
On battery power	Select the number of minutes of inactivity you want to pass before the terminal goes into suspend mode when running on battery power.
On external power	Select the number of minutes of inactivity you want to pass before the terminal goes into suspend mode when running on external power.

Regional Settings

Regional Settings enables you to customize the appearance and formatting to your geographic region. Specifically, you can customize numbers (i.e., number of decimal places allowed), currency (i.e., using the \$ or € symbol), time, and date.

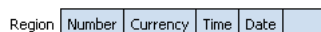
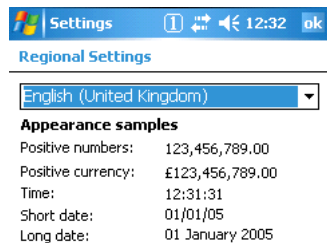

These specifications apply to all screens, including the Today screen. The Region tab displays an overview of the region selected in the drop-down list at the top. The terminal is loaded with a number of pre-programmed regional settings. Select one from the list and the results appear on the screen.

To see specific settings or change a specific setting, tap on one of the tabs, make the change and tap **OK** to save it. You need to show reboot the terminal for the changes take effect.

Remove Programs

The Remove Programs settings enables you to remove programs installed on the terminal. Use this setting to troubleshoot when you receive messages that the device is out of memory. The programs removed in the Remove Programs setting are removed from volatile memory.

1. Tap **Remove Programs**. In the list, select the program you want to remove.



2. Tap **Remove**. The following message appears:

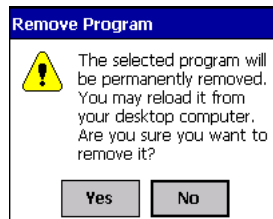

3. Tap **Yes**. Wait while the program is removed.
4. Verify that the program no longer appears in the list and the total storage memory adjusts.

Total storage memory available—The available memory adjusts automatically when a program is removed; see [Memory](#) on page 6-10.

Screen

Note: By default, dynamic screen rotation (i.e., the ability to switch between landscape and portrait orientation) is disabled on Dolphin 7850 terminals.

Alignment Tab

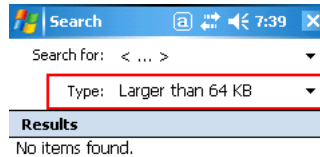

Tap **Align Screen** to re-align the screen. Remember, you first align the screen at bootup. You would need to re-align the screen again if tapping buttons or icons with the stylus no longer seems to work appropriately.

ClearType Tab

Dolphin terminals support ClearType font rendering. ClearType is a Microsoft technology that dramatically increases the readability of text on LCD displays.

To enable ClearType font rendering, select **Enable ClearType** and tap **OK**.

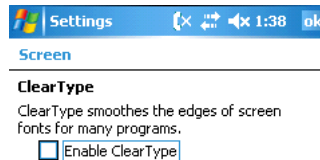

For more information about ClearType font rendering, visit: www.microsoft.com/typography/cleartype/what.htm?fname=%20&fsize=

Text Size Tab

Adjusts font scaling within certain views of the Today screen, Contacts, Calendar, Messaging, and Tasks. This means that you can increase or decrease the point size of the font on application windows.

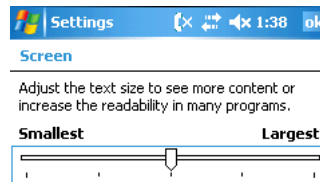

This is the default font size setting. To change the font size, move the slider toward **Smallest** or **Largest**. The Example text changes to reflect the font change. Tap **OK** to save the new font size setting.

Default Font Size

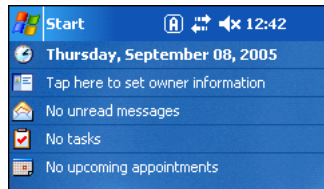

Largest Font Size

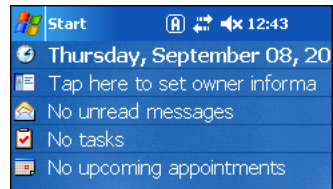

Communication Options

Dolphin terminals offer a number of communication options including Microsoft ActiveSync, infrared, and wireless radios.

I/O Connector

The industrial-grade, 17-pin, mechanical connector on the bottom panel (see [I/O Connector](#) on page 3-9) connects the terminal to a series of Dolphin peripherals that connect to a host workstation via USB (1.1 or higher).

When the terminal is connected to a host workstation in this way, you can use ActiveSync to communicate between the host and the terminal. For more information about communicating with ActiveSync, see [Using ActiveSync](#) on page 7-3.

IrDA Port

The IrDA port enables the Dolphin terminal to transmit data via pulses of infrared light to and from other IrDA-compliant devices, such as printers, PCs, and even other Dolphin terminals.

For more information about communicating via the IrDA port, see [Using Infrared Communication](#) on page 7-8.

Wireless Radios

Dolphin 7850 terminals can be equipped with a WLAN and/or Bluetooth radio. When the terminal's radios are enabled, you can connect the terminal to a wireless network for communication.

For more information about enabling the radios, see [Radio Manager](#) on page 7-13.

Software Communication Programs

Dolphin terminals are shipped with the following communication software programs installed.

Microsoft ActiveSync v4.5 or Higher

Microsoft ActiveSync is a tool that enables mobile computing devices to exchange and synchronize application data with a desktop computer. For more information, see [Using ActiveSync](#) on page 7-3.

Remote Access Services (RAS)

RAS is a feature built into Windows NT that enables users to log into an NT-based LAN using a modem, X.25 connection or WAN link. RAS is fully supported and allows the use of Point-to-Point Protocol (PPP) or Serial Line IP (SLIP) connections for network connectivity.

To establish a RAS connection, enable the terminal's radio(s) in the [Radio Manager](#) (see page 7-13), set the terminal up on a wireless network, then activate the RASMan Power Tool by tapping **Start > Power Tools > RASMan**.

For more information about Power Tools, refer to the Dolphin Power Tools User's Guide, which is available for download from www.honeywell.com/aidc.

Default COM Port Assignments

The Dolphin terminal ships with the COM ports assigned as follows:

COM Port	Assignment
1	Serial port; this is the I/O connector on the bottom panel. See I/O Connector on page 3-9.
2	Bluetooth Module If there is no Bluetooth hardware installed on the terminal, this com port is unassigned.
3	Raw Infrared
4	Unassigned
5	USB virtual serial port
6	IrDA, if IrDA is enabled. If IrDA is disabled, this com port becomes available.
7, 8, & 9	Unassigned These are virtual com ports that are available for selection only when connecting to devices that use virtual com ports, such as Bluetooth.

Installing Additional Software

Dolphin terminals ship with the operating system, radio drivers, and custom Honeywell software loaded onto the device. These are the default programs that install when your terminal first boots up. You can install additional software programs to the terminal provided that the following parameters are met:

- The software program was created for a Windows Mobile device.
- The terminal has enough memory to store and run the program.
- The program has an EXE, CAB, or DLL extension.

The most popular place to find software on the Windows Mobile web site: www.microsoft.com/windowsmobile/products/pocketpc/

 *When selecting programs, verify that the program and version of the program are designed for the Windows Mobile 5.0 and the terminal's processor. You can verify your processor by tapping Start > Settings > System tab > About > Version tab. Make a note of the information in the Processor field.*

To install additional software, you can use the communication options described in this chapter.

See,

- [Adding Programs via ActiveSync](#), page 7-4.
- [Adding Programs From the Internet](#), page 7-7.
- [Adding Programs via Infrared](#), page 7-9.

Using ActiveSync

ActiveSync communication happens through the I/O connector on the bottom panel (see [I/O Connector](#) on page 3-9) when the terminal is connected to a Dolphin communication peripheral such as the Dolphin HomeBase device or a charge/communication cable.

Hardware Requirements

- Dolphin communication peripheral or cable: USB or RS-232
- Power Adapter Cable from Honeywell

Software Requirements

To synchronize, ActiveSync 4.5 or higher must be installed and configured for the appropriate communication type on the host workstation and the Dolphin terminal. Dolphin terminals ship with ActiveSync already installed. Therefore, if ActiveSync is already installed on the host workstation, you just need to connect the Dolphin terminal to the host workstation (via Dolphin peripheral) to initiate communication.

If ActiveSync 4.5 or higher is not installed on the host workstation, install it from the Getting Started CD that came with the Dolphin terminal. Insert the CD into the CD-ROM drive of the host workstation and follow the directions on your screen. You can also download the most current version of ActiveSync from www.microsoft.com and install.

The host workstation must have Windows 98 Second Edition*, Windows Me, Windows 2000, or Windows XP installed.

*Note: The HomeBase device does not support Windows NT when using a USB connection because Windows NT does not support USB. *Windows 98 Second Edition provides full USB support.*

Setting Up the Host Workstation

To sync successfully, ActiveSync must be configured for same communication type on the host workstation and the Dolphin terminal. ActiveSync must be setup on your desktop computer *before* you initiate synchronization from the terminal for the first time.

Verify that ActiveSync on the host workstation has selected the appropriate communication type by opening ActiveSync and clicking **File > Connection Settings**.

For USB communication,
check **Allow USB connections**.

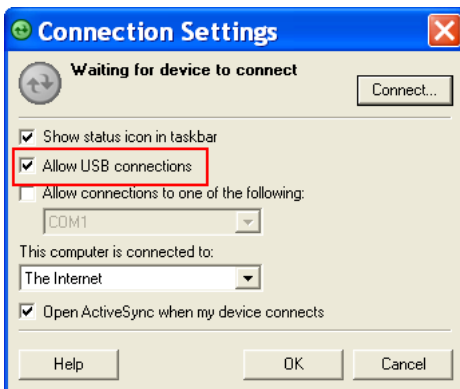

For RS-232 communication,
connect to **COM1**.

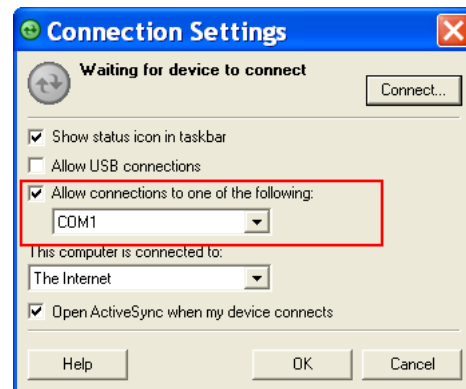

Note: You can have both USB and RS-232 selected in the software without affecting processing. However, your hardware setup should use only RS-232 or USB, not both.

Setting Up the Terminal



When communicating via ActiveSync, your terminal is designed to be connected to the host workstation with a Honeywell communication peripheral. We recommend use of Honeywell peripherals, power cables, and power adapters. Use of any non-Honeywell peripherals, cables, or power adapters may cause damage not covered by the warranty.

You need to connect the Dolphin peripheral to the host workstation, then connect the Dolphin terminal to the peripheral. ActiveSync should attempt to connect automatically and self-configure to RS-232 or USB. Dolphin terminals default to USB communication.

Verify the connection setting on the Dolphin terminal by tapping **Start > Programs > ActiveSync > Menu > Connections**.

USB The default workstation synchronization value for USB communication is **'USB Connection**.

RS-232 The default workstation synchronization value for RS-232 communication is **'115200 Default**.

Synchronizing with the Host Workstation

After setup, synchronization begins automatically whenever the terminal's I/O connector connects to a Dolphin peripheral that is connected to a host workstation with ActiveSync installed.

Note: If you have a wireless LAN card, you can also synchronize remotely.

Exploring the Terminal from the Workstation

When the terminal and desktop computer are connected, open the main ActiveSync window (on the desktop), and click **Explore**.

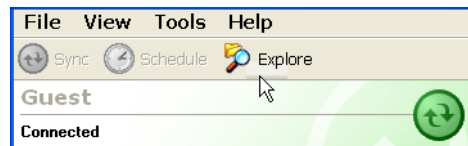

The Mobile Device folder opens in Windows Explorer.

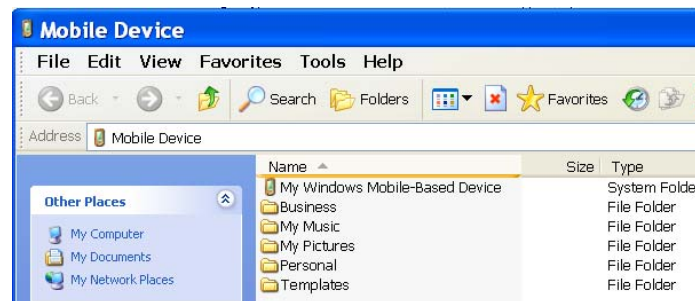

The Dolphin terminal is now treated as a mass storage device, and transferring files is as simple as dragging and dropping or copying and pasting as you would for moving files between folders on your hard drive.

Adding Programs via ActiveSync



When selecting programs, verify that the program and version of the program are designed for Windows Mobile 5.0 and your processor. You can verify your processor by tapping **Start > Settings > System tab > About > Version tab**. Make a note of the information in the Processor field.

Generally, software for Windows Mobile devices must be installed to the host workstation first, then transferred to the Dolphin terminal.

-
1. Download the program to the workstation from either the Internet or the installation CD. You may see a single *.exe or setup.exe file, a *.cab file, or *.dll. (There may also be several versions of files for different device types and processors.)
 2. Read any installation instructions provided by the program, such as Read Me files or other documentation. Many programs provide special installation instructions.
 3. Connect the terminal to the workstation via Dolphin communication peripheral.
 4. Confirm that ActiveSync activates.

If the Program File is Self-Extracting

This type of program installs to the workstation and the terminal simultaneously; one process installs to both devices.

1. On the workstation, double-click the *.exe or *.setup.exe file. The installation wizard begins.
2. Follow the directions on the workstation screen. The installation process includes transferring the software to the terminal via ActiveSync.

If the Program File is Not Self-Extracting

Some programs cannot be installed on workstations because they are designed exclusively for Windows Mobile devices. In these cases, the appropriate files must be stored on the host workstation and transferred to the terminal via ActiveSync Explore.

Note: You know that the program is not an installer because an error message stating that the program is valid but designed for a different type of computer appears when you try to install the program on the workstation.

1. If you cannot find any installation instructions for the program in the Read Me file or documentation, open **ActiveSync** and click **Explore**.
2. Navigate to the **My Windows Mobile-Based Device** folder and copy the program file or files to the **Program Files** folder on the terminal. If you want the program to be part of the Autoinstall that occurs after every hard reset, place the program file in the **Autoinstall** folder (\\IPSM\AutoInstall).
3. On the terminal, tap **Start > Programs > File Explorer** and navigate to the folder where the program is located.
4. Tap on the program file to install it.
If you copied the file to the **Autoinstall** folder, you can also choose to install the program by performing a hard reset. The program installs as part of initialization.
5. After installation is complete, access the program by tapping **Start > Programs** and the program appears on the Programs screen. Tap the icon to open the program.

For Additional Help

You can find more information on the host workstation by clicking **Help > Microsoft ActiveSync Help**.

You can find more information on the terminal by tapping **Start > Programs > Help > ActiveSync**.





For more information, go to the Windows Mobile software website at: www.microsoft.com/windowsmobile/products/pocketpc/

Connections Tab

The Connections Tab of Windows Mobile Settings provides access to the configuration settings for many of the terminal's communication options. Tap **Start > Settings > Connections** tab.



Note: The programs that appear on the Connections tab depend on the terminal's radio configuration.

Program	Icon	Description	See Page
Beam	 Beam	Controls infrared communication.	7-8
Connections	 Connections	Accesses the connections manager to set up modem connections.	7-10
Network Cards	 Network Cards	Opens the network adapters tool.	7-12
Radio Manager	 Radio Manager	Enables and disables installed radio drivers.	7-13
USB to PC	 USB to PC	Toggles the terminal between RNDIS USB and Serial USB communication. Dolphin terminals default to Serial USB.	7-15

Connecting the Terminal to a Wireless Network

Establishing the terminal on a wireless network depends heavily on your network infrastructure. You will need specific information from your network administrator.

Whatever your network specifics, some general steps apply:

1. The on-board radio drivers must be enabled for the terminal to transmit a signal. Verify the radio's status in the [Radio Manager](#) (see page 7-13).
2. Enter the appropriate configuration settings for each radio installed. Each radio has its own configuration program.
 - For details about configuring the WLAN radio, refer to the Honeywell WLAN Security Supplement User's Guide, which is available for download from www.honeywell.com/aidc.
 - For details about Bluetooth radio, see [Wireless PAN Communication with Bluetooth](#) on page 8-1.

Connecting the Terminal to an ISP

This method uses an external modem rather than a wireless radio. For instructions, see [Proxy Server Connections](#) on page 7-11.

Adding Programs From the Internet

When you have established a network connection (via modem or wireless radio), you can access the Internet and download additional software programs.



When selecting programs, verify that the program and version of the program are designed for the Windows Mobile 5.0 and the terminal's processor.

1. Verify the terminal's processor by tapping **Start > Settings > System tab > About > Version** tab. Make a note of the information in the **Processor** field.
2. Open Pocket Internet Explorer and navigate to the program's location. You may see a single *.exe or setup.exe file, or several versions of files for different device types and processors.
3. Select the program version that matches the terminal and processor.
4. Read any installation instructions provided by the program, such as Read Me files or other documentation. Many programs provide special installation instructions.
5. Download the program to the terminal straight from the Internet. You would normally store the program in the **\Program Files** folder unless another location is required by the program.
6. On the terminal, tap the installer file, often an *.exe file.
7. The installation wizard for the program begins.
8. Follow the directions on the screen to complete installation.

Using Infrared Communication

The IrDA port sends and receives data between the terminal and other devices equipped with infrared. The maximum data transfer speed is 115 Kbps with a duty cycle of 18.75%.

IrDA Port Location

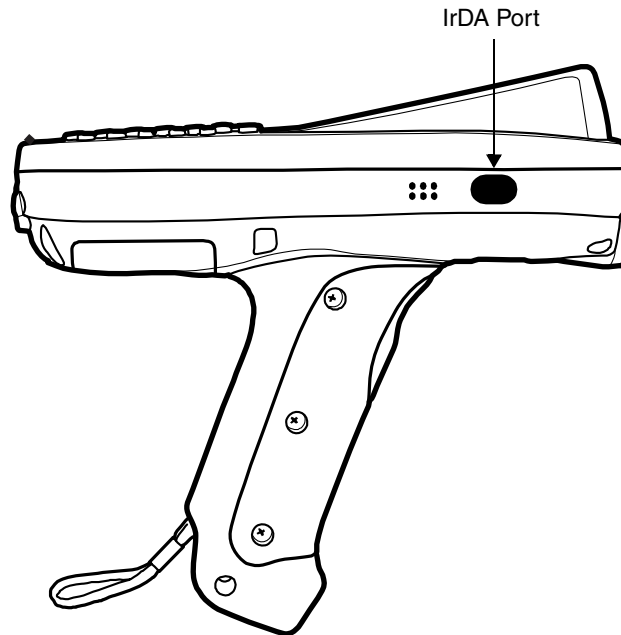

Verify Beam Settings

By default, the IrDA port is enabled after each hard reset. This means that the IrDA port is ready to send and receive data via infrared. Tap **Start > Settings > Connections tab > Beam**.

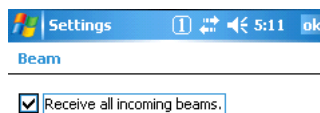

Receive all incoming beams... must be checked for the terminal to receive infrared data from another device.

Sending Data

You can send and receive information via infrared, including software programs (.exe files).

To send or receive, the IrDA ports of both devices must be aligned with each other and within a close range. The maximum data-transfer speed is 115 Kbps.

1. Align the IrDA ports of both devices. (When sending data from one Dolphin terminal to another, position both terminals so that the IrDA ports are facing each other directly.)
2. Open the program where you created the item you want to send and locate the item in the list. You can beam files, but not folders, from File Explorer.

-
3. Tap and hold the item and select **Beam File**.

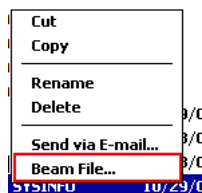

4. The information begins transmitting to the other infrared device.

Receiving Data

1. Verify that the terminal is set to receive all incoming beams; see [Verify Beam Settings](#) on page 7-8.
2. Align the IrDA ports.
3. Have the owner of the other device send the information to you via infrared.
4. Your terminal automatically begins receiving it.

Adding Programs via Infrared

Select a program on one terminal and beam it to another to load additional software programs to Dolphin terminals.

Troubleshooting

If the Beam Settings are not set to receive or you've aligned two IrDA ports and the terminal is still not receiving, tap **Start > Programs > Infrared Receive**. The terminal searches for the sending device.

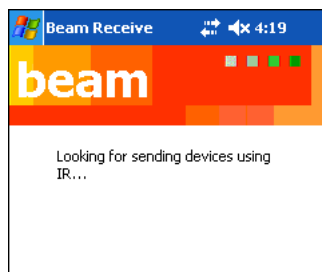

If the terminal cannot find the sending device, the following message appears:

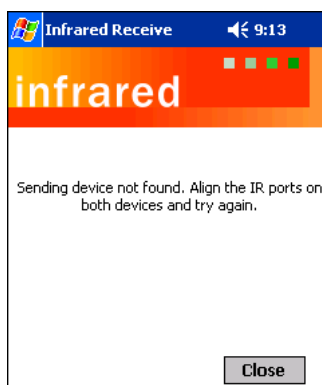

Connections Manager

The connections manager sets up various network connections to Internet Service Providers (ISPs) via an external modem.

If you are using one of the on-board wireless radios to connect to a network, do **not** enter network parameters in the connections manager. The Dolphin terminal uses the radio's settings to connect to the network.

*Note: All server-assigned IP addresses use Dynamic Host Configuration Protocol (DHCP). The zero-config WLAN feature of Windows Mobile is **disabled** on Dolphin terminals.*

To open the connections manager, tap **Start > Settings > Connections** tab > **Connections** icon . The connection manager opens displaying the Tasks tab.

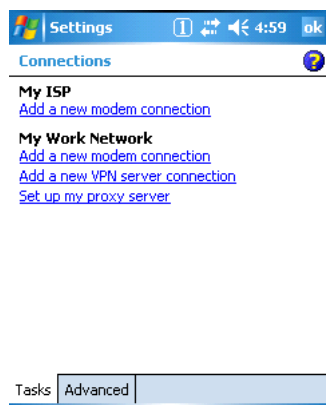

Task Tab

The Task tab enables you to initially configure, then manage network settings when using a modem. Select an item in this list and then complete the setup screens that follow with the appropriate information for your network.

My ISP

The links under this heading enables you to add and manage modem connections to an ISP. To complete the setup screens, obtain the following information from your ISP:

- ISP dial-up access telephone number
- Username
- Password
- TCP/IP settings

My Work Network

These links enable you to establish the following connections types:

- Modem
- Virtual Private Network (VPN)
- Proxy server connection

To complete the setup screens, obtain the network parameters from your system administrator.

Proxy Server Connections

If you are connected to your ISP or private network during synchronization, the terminal should download the proper proxy settings during synchronization with the workstation. If these settings are not on your workstation or need to be changed, ask your ISP or network administrator for the proxy server name, server type, port, type of Socks protocol used, and your user name and password.

Modify an Existing Connection

Manage Existing Connections appears on the Connections tab after at least one network connection has been established. Tap Manage Existing Connections on this tab and follow the setup screens. You will usually be walked through the same setup screens used to establish the connection.

Advanced Tab

The Advanced tab enables you to select the default network, dialing rules, and IP address exceptions for modem connections.

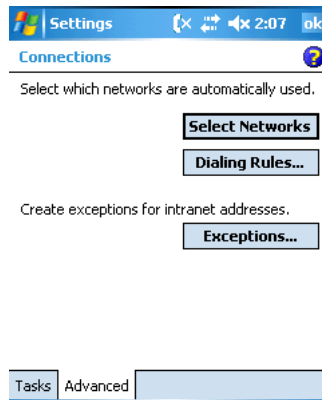

Note: You should not need to change Advanced settings because most ISPs now use DHCP addresses.

Online Help

For more information about modem connection setup, consult the online help on the setup screens by tapping the Help icon .

Network Cards



The Connections tab (see [Connections Tab](#) on page 7-6) contains a Network Cards icon that displays the network cards installed in the terminal.

1. Tap **Start > Settings > Connections > Network Cards**

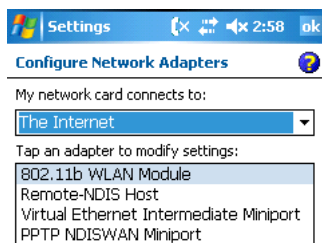

2. Tap on an adapter in the list to review its settings. (Server-assigned IP addresses use DHCP.)

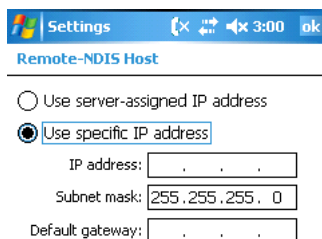

3. If you make a change on one of these tabs, tap **OK** to confirm the changes.
4. You must perform a soft reset to update the registry entries; see [Soft Reset \(Warm Boot\)](#) on page 3-15. During the soft reset, the new registry entries are created and can be read by the applications that need them.



Do NOT perform a [Hard Reset \(Cold Boot\)](#) (see page 3-15) after modifying an adapter here. Hard resets return the terminal to factory defaults, which erases network adapter modifications made here.

Radio Manager

The Radio Manager enables and disables the radio drivers installed in the terminal. When a radio is enabled, the radio is transmitting a signal. When disabled, the radio is not transmitting a signal.

At least one radio **must** be enabled before you can set the terminal up on a wireless network. After the radio is enabled, you can enter the appropriate network parameters for your network. If the radio is disabled, the terminal doesn't connect.

Dolphin 7850 terminals can be configured with a WLAN and/or Bluetooth radio.

Radio Driver Installation

For a radio to show up in the Radio Manager, both the hardware module and the software driver for each radio must be installed in the terminal. The radio will appear in the Radio Manager if the module is present but cannot be enabled if the associated driver is not installed as well. All radios and radio drivers are co-located inside the terminal.

Radio drivers (.cab files) are stored in the Autoinstall folder and install during the Autoinstall process after each hard reset (see page 3-15). Only the appropriate drivers for the terminal's radio configuration install. For more information about Autoinstall, refer to the Dolphin Power Tools User's Guide, which is available for download at www.honeywell.com/aidc.

Enabling the Radios

The terminal enables the WLAN radio after each hard reset by default. Verify the status of the radio before attempting to establish or change network connection settings.

1. Tap **Start > Settings > Connections** tab > **Radio Manager** .
The Radio Manager appears identifying that radios and radio combinations that can be enabled.

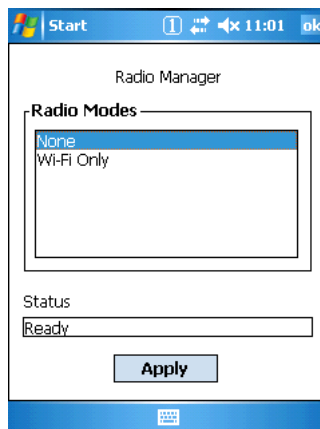

2. Select the radio or radio combination in the list and tap **Apply**. The Radio Manager attempts to enable the radio.
3. When the radio is enabled, the **Status** field reads "Success." If an error occurs during a radio mode change, an error message appears in the Status field and the change is abandoned.

Radio Manager Window

Field	Description
Radio Modes	Displays the radio hardware modules currently installed on the terminal.
Status Field	Provides feedback on the state of the radio. The Status field reads "Ready" when the selected radio is enabled and the Radio Manager is ready to receive a command. Otherwise, the Status field displays the following messages when enabling a radio: <ul style="list-style-type: none">• Success=The radio or radio combination has been successfully enabled.• WLAN error messages=Indicate that the radio could not be enabled.

Disabling Radios

To power down all radios, select **None** and tap **Apply**. All radios are disabled.

USB to PC

The USB to PC applet enables you to switch between RNDIS (Remote Network Driver Interface Specification) USB and Serial USB communication.

Dolphin 7850 terminals default to Serial USB. Honeywell recommends using Serial USB.

To change this setting, tap **Start > Settings > Connections** tab > **USB to PC** . The enable option is not selected, which indicates Serial USB.

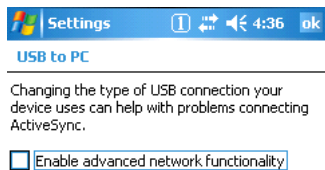

To switch to RNDIS USB, select **Enable advanced network functionality** and tap **OK** to save. (Wait as the terminal makes the change.)



Bluetooth Radio

The on-board Bluetooth radio is enabled by default at startup and operates within the 2.4 GHz–2.48 GHz band. Bluetooth transmissions hop between 79 separate frequencies 1,600 times every second, and with a communication range of about 10 meters (class II).

Enabling the Bluetooth Radio

The Bluetooth radio must be enabled in order to connect to other devices. You'll know that the radio is not enabled if there is a yellow explanation point over the Bluetooth icon .

By default, the WLAN radio is enabled after each hard reset. Therefore, you must enable the Bluetooth radio in the [Radio Manager](#) (see page 7-13). Tap **Start > Settings > Connections tab > Radio Manager**. Select **Bluetooth Only** or **Wi-Fi/Bluetooth**, then tap **OK** to enable the radio.

BTE Explorer

BTE Explorer discovers Bluetooth devices in range and presents them in an easy-to-understand format similar to Windows Explorer. BTE Explorer visually separates trusted (paired) and untrusted remote devices and identifies friendly names and services of remote devices. Custom icons indicate the device class (type) as well as available services.

The services supported by the local device include

- File transfer
- OBEX
- OBEX object push
- FAX
- LAN access
- Dial-up networking
- Serial port communication

Pairing, security, and encryption settings can be configured for the local device. In addition to the configuration options available, any of the supported services may be added to or removed from the local device.

Accessing BTE Explorer

When the Bluetooth radio is enabled, the Bluetooth icon on the Today screen appears as follows . Tapping this icon once opens BTE Explorer to the Favorites window.



Note: When the Bluetooth radio is disabled, tapping this icon opens a warning message, which states that the radio is not enabled and to go to the Radio Manager as described in [Accessing BTE Explorer](#) on page 8-2.

Using BTE Explorer

BTE Explorer has a New Connection Wizard for each type of Bluetooth connection you want to make; see [Connection Types](#) on page 8-7. You open BTE Explorer, select the connection type, BTE Explorer scans for matching devices and services, and the connection wizard walks you through the connection process.

Different connection types will require different information. Make sure you have all the necessary information (PIN numbers, passkeys, MAC addresses, etc.) from the devices you want to connect to.

1. When the Bluetooth radio is enabled, tap the Bluetooth icon on the Today screen once . BTE Explorer opens to the Favorites window.



BTE Explorer always opens to the Favorites window, which displays the Bluetooth connections saved as Favorites on the terminal. Use this window as a quick way to connect to established Bluetooth connections.

2. Tap **File > New Connection** and the New Connection Wizard opens.
3. Select the action you want to perform from the drop-down list below.

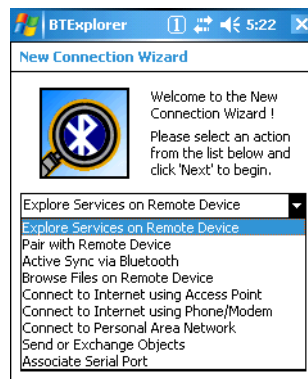

- Click **Next** and BTE Explorer scans for other Bluetooth devices in range and displays the search results.

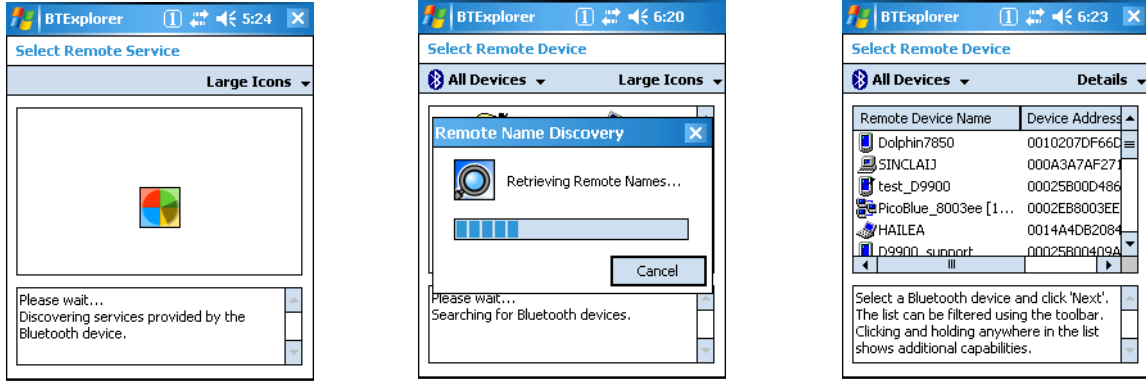

- Select a device and click **Next**. BTE Explorer attempts to connect to the selected device and explore the device's available services.

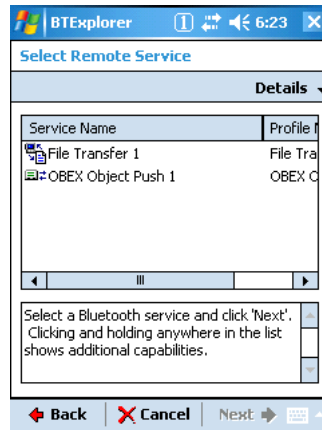

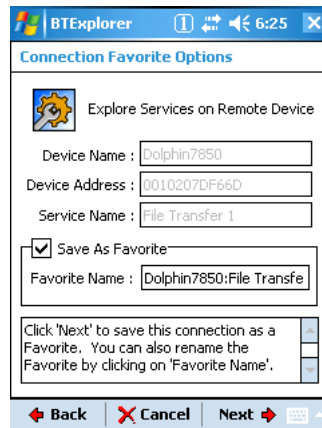

- Select a service in the list and tap Next. The next window enables you to save the device connection and service as a Favorite.

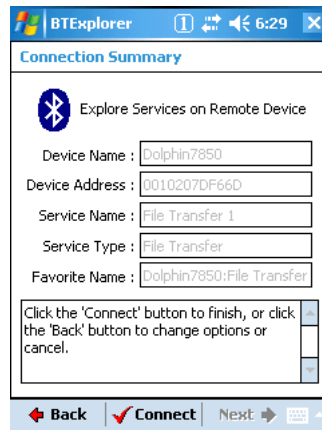

- Leave Save As Favorite selected to save this connection as a Favorite and type in the Favorite Name. If not, uncheck the option.

b. Review the contents of the window and tap **Next**. The connection summary appears.



7. Tap **Connect**. If you are transferring files, the next steps are to select the file(s) and transfer them to the device.
8. While the terminal is transferring data, the icon on the Today screen will display a green, double-sided arrow over the Bluetooth icon .
9. The next time you open BTExplorer, any connection you saved as a Favorite will appear.

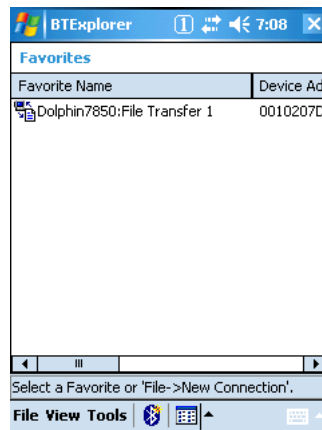

Favorites

BTE Explorer enables you to save connections to specific devices and the services on those devices as Favorites. Each time you try to connect to a device and service manually, you are asked if you want to save the connection as a Favorite. You can even give each connection a unique name.

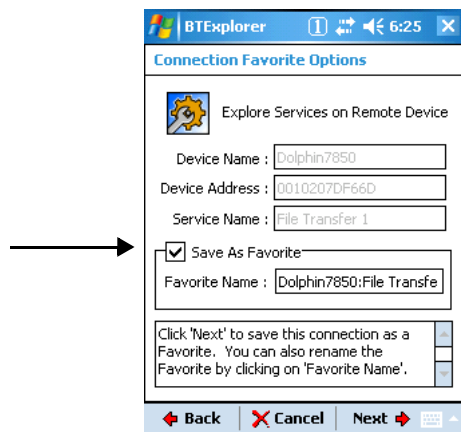

Favorite connections appear on the opening window each time you open BTE Explorer.

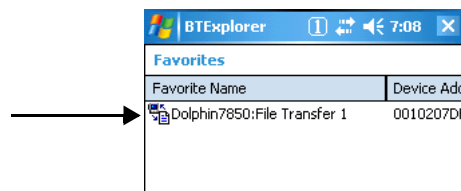

Just tap and hold on the Favorite and the list and select **Connect** on the popup menu to connect to that device and service(s).

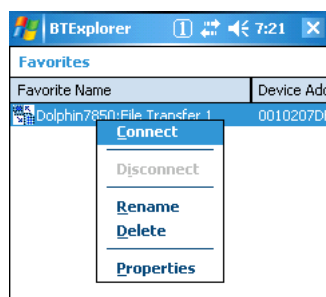

Favorites do persist through cold boots.

Navigation Buttons

Bluetooth Explorer contains the following navigation buttons at the bottom of every wizard screen:

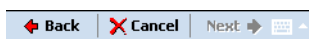

- Back** Move back on screen in the wizard.
- Cancel** Cancel the setup and return to the New Connection window.
- Next** Save the information on the current setup screen and move to the next.

Connection Types

Connection Type	Allows the Bluetooth radio to...	Requirements
Explore Services on Remote Devices	Discover available services.	Discoverable Bluetooth devices with activated services must be in range for the terminal to retrieve devices and services.
Pair with Remote Device	Pair with remote devices.	The correct PIN number of the device you're attempting to pair with.
ActiveSync via Bluetooth	Synchronize files and data with a remote workstation via Bluetooth ActiveSync.	Matching Bluetooth ActiveSync settings.
Browse Files on Remote Device	See files on a remote device.	A working Bluetooth connection with the remote device.
Connect to Internet using Access Point	Connect to the Internet using LAN or a network gateway.	A Bluetooth-compatible access point.
Connect to Internet using Phone/Modem	Connect to the Internet using a mobile phone or mobile phone modem using dial-up networking.	Dial-up account information.
Connect to Personal Area Network (PAN)	Connect to another Bluetooth device that allows participation in a PAN.	Another device that is set up as part of an existing PAN.
Send or Exchange Objects	Send or exchange business cards, contacts, pictures, appointments, and tasks with another Bluetooth device.	A working Bluetooth connection to a remote device.
Associate Serial Port	Make a favorite to a Bluetooth serial port device.	

Device Types

BTE Explorer supports the following device types:

- Audio Devices
- Network Devices
- Phones
- Printers
- Computers
- OBEX Devices

By default, BTE Explorer scans for **Network Devices**.

To change the, device type, tap on the arrow to the right of the heading on the left. The name of this heading changes depending on what device type is selected; it can say “Filter” or “Bluetooth Devices.”



Select another device type in the list.

View Options

Discovered Devices appear with an icon indicating what type of device it is and the Device ID.

By default, the discovered devices screen appears in the Large icon view. The Details menu offers you alternate view options. (When you select the Details menu, its name changes to “View.”)

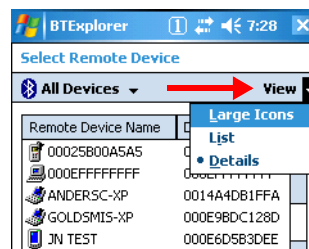

Large Icons

Displays large icons in the viewing area.

List

Displays small icons in a one-column list.

Details

Displays small icons in a list with two columns:

Remote Device Name The Device ID.

Device Address The MAC address.

Trusted The status of this device.

Trusted=The device is trusted.

False=The device is not trusted.

Menu Options

The discovered devices window has a popup menu that enables you to perform several tasks. You can select a device and tap and hold or just tap and hold on an empty space; the same menu appears. Certain menu items are enabled or disabled depending on which method you use.

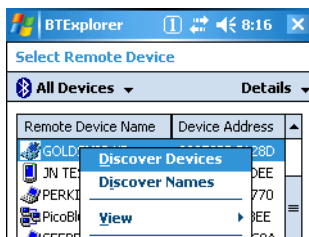

Menu Item	Description
Discover Devices	Scans for Bluetooth devices.
Discover Names	Scans for device names.
View	<p>Opens a side menu that offers you sorting options for the discovered devices list.</p> <ul style="list-style-type: none"> • All Devices—Shows all devices in the vicinity. • Trusted Devices Only—Removes untrusted devices from the display. • Untrusted Devices Only—Removes trusted devices from the display. <p><i>Note: These options affect only what appears on the display, not what devices the Bluetooth radio has discovered.</i></p>
Delete All Devices	Deletes all the discovered devices.
*Delete Device	Deletes a selected device.
*Properties	<p>Displays the properties of a selected device. Tap OK (either one) to return to the discovered devices window.</p>
Refresh	Scans for Bluetooth devices.

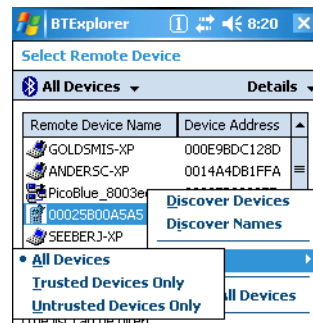

*These items are active only when a device is selected when the pop-up menu appears.

Discovered Devices

In order for the terminal to find a device when scanning, that device must be Discoverable by Bluetooth. If not, the terminal won't find the device when scanning. Furthermore, the device must have activated Bluetooth services. The terminal will retrieve only discoverable devices and the services activated on that device.

Refreshing Discovered Devices

If your Bluetooth device doesn't show up in the list, scan again by tapping and holding on the window and selecting Refresh on the pop-up menu.

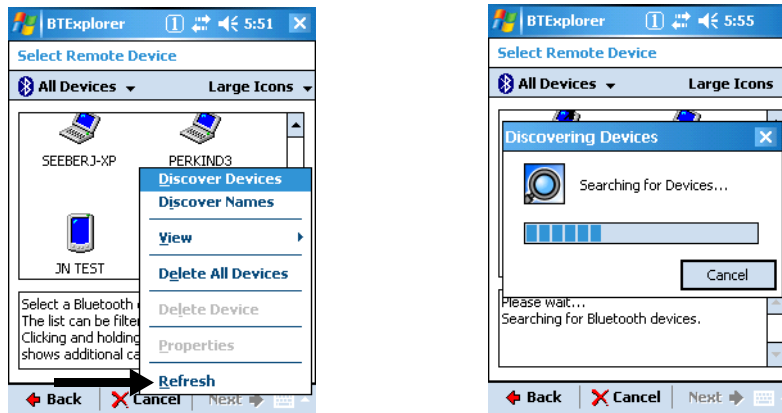

Note: By default, this window displays the devices found on the first search but does not refresh automatically when you open it again. If you make any changes to the discoverable status of a Bluetooth device in range of the terminal, make sure that you refresh this window.

Making the Terminal Discoverable

If you want other Bluetooth devices (including another Dolphin terminal) to be able to retrieve the terminal in a scan, you must 1) make it discoverable and 2) activate specific services.

Discoverable status does not persist through cold boots.

1. On the Favorites window, tap **Tools > Settings**.

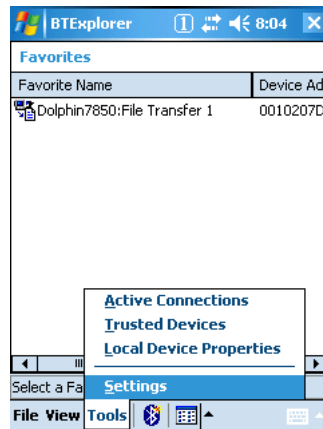

-
2. Set **Discoverable Mode** to **Discoverable**.
Set **Connectable Mode** to **Connectable**.
You must change both for the terminal to be discoverable.

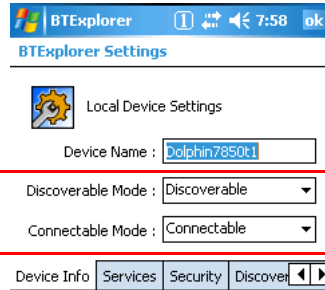

3. To activate specific services, tap the **Services** tab and tap **Add**.

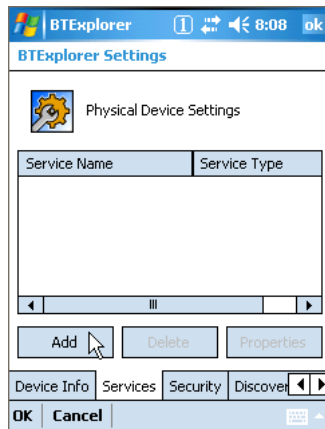

4. Select a service and tap **OK** to add.

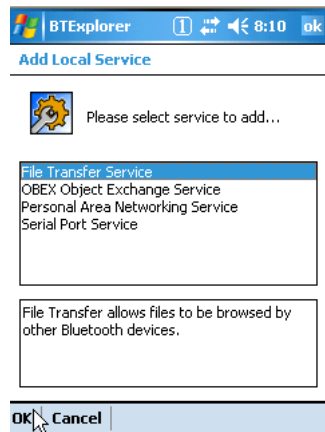

-
5. Each service you select is going to take you through a series of windows to confirm the parameters of the service.
For example, for the file transfer service, the following window appears:

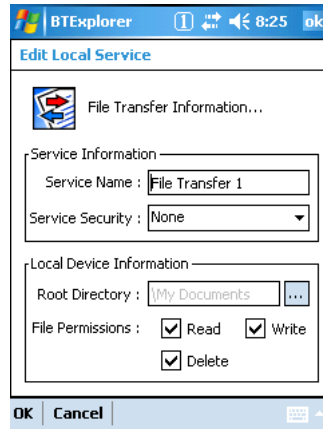

6. Tap **OK** and you are returned to the prior window, which now displays the service as active.

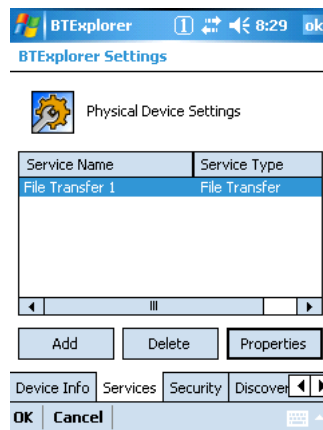

7. Repeat Steps #4–6 for the services you want to activate.
8. The Dolphin terminal and its services are now activated and can be discovered by another Bluetooth device.

Pairing

Pairing associates Bluetooth devices with each other so that you don't have to enter access information every time a connection is requested. Bluetooth devices need to be paired with each other before attempting a connection the first time.

Paired devices remain paired, even if:

- One of the devices is not powered.
- A service connection is interrupted or stopped.
- One or both devices are rebooted.

Passkey

Paired devices share a unique passkey both devices use to authenticate when connecting. The passkey can be alphanumeric, numbers, or letters, and must consist of one or up to 16 characters.

Trusted Devices

Trusted devices are paired devices.



Dolphin HomeBase Device

Overview

As the hub of your system, the Dolphin HomeBase charging and communication cradle supports both RS-232 and USB communication, enabling your terminal to interface with the majority of PC-based enterprise systems.

Communication

RS-232 transmits data at speeds of up to 115 Kbps. With USB port, the data transmission rate goes up to 12 Mbps.

These bases cannot be physically connected to each other—sometimes referred to as “daisy-chaining”—but can be networked together through serial or USB hubs.

Convenient Storage

Intelligent battery charging makes the base a safe and convenient storage receptacle for your terminal.

Capacity

The base can charge two battery packs: the one that’s installed in the terminal seated in the well and the other in the auxiliary battery well on the back panel. While charging the battery pack in the terminal, the base also powers the Dolphin terminal. The auxiliary battery well charges a battery pack independently of the terminal well.

Intelligent Battery Charging

The base completes a full charge of the main battery pack in less than four(4) hours.

In addition to charging, the base powers the intelligent battery charging system in the terminal that protects the battery from being damaged by overcharging. The terminal senses when a battery pack is fully charged and automatically switches to a trickle charge that maintains the battery at full capacity.

As a result, terminals may be stored in the base without damage to the terminals, battery packs, or peripherals.

Power Supply

The base is available with US, UK, and European power supplies. Each version is designed to convert the voltage from the power sources in each geography to the 7.4 volts DC required by the terminal.



We recommend use of Honeywell Li-Ion battery packs. Use of any non-Honeywell battery may result in damage not covered by the warranty.

For complete information about batteries, see [Battery Power](#) on page 3-11.



We recommend use of Honeywell peripherals, power cables, and power adapters. Use of any non-Honeywell peripherals, cables, or power adapters may cause damage not covered by the warranty.

Front Panel

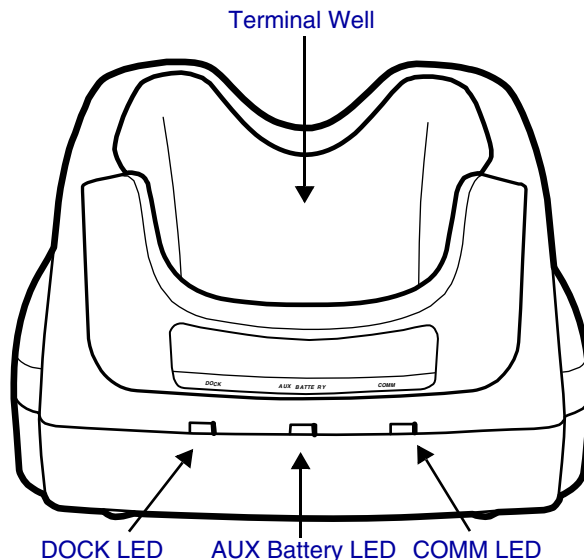

AUX Battery LED

Indicates status of the battery charging in the auxiliary battery well; see page 9-4.

- Orange** The auxiliary battery is charging.
- Green** The auxiliary battery has completed charging and is ready for use.

COMM LED

The COMM LED indicates the status of data transfer between the Dolphin terminal and the host workstation. The color of this LED differs if the base is using the serial or USB port connection.

If using a serial port connection

- Red** Serial data is being sent from the host device to the base.
- Green** Serial data is being sent from the base to the host device.
- Orange** Serial data is being sent at high data rates.

If using a USB port connection

- Green** A USB connection is established with the host workstation.

DOCK LED

Turns solid green when the terminal is properly seated in the base. When this light is on, the terminal is connected to the base.

Terminal Well

Place the terminal in this well to communicate with a host device, power the terminal, and charge its battery pack. The back of the terminal well features a saddle to accommodate the integrated pistol-grip handle.

Back Panel

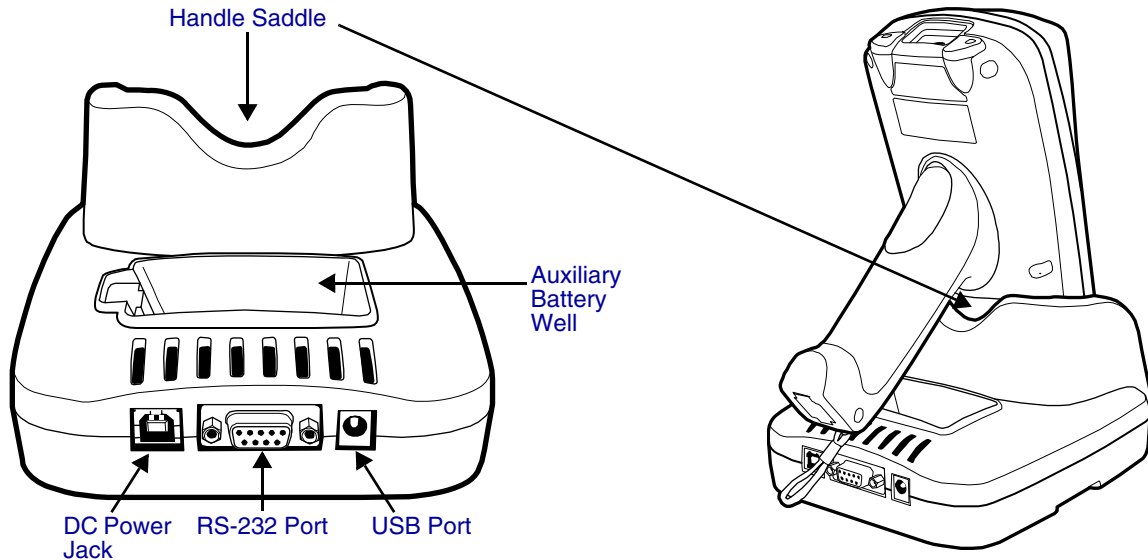

Auxiliary Battery Well

The auxiliary battery well charges an additional Li-ion battery pack independently of the terminal well. This feature ensures that you can always have a fully-charged battery for your terminal; see [Charging a Spare Battery Pack](#) on page 9-4.

DC Power Jack

Connect the power cable to this power jack; see [Power](#) on page 9-5.

Handle Saddle

The curve on the back wall of the terminal well accommodates the pistol-grip handle when the terminal is seated in the well.

RS-232 Port

For RS-232 data communication, use the 9-pin, RS-232 cable from Honeywell to connect this port to a peripheral device. For more information, see [RS-232 Serial Connector](#) on page 9-6.

USB Port

This USB Port is full-speed, 2.0 compliant, and requires ActiveSync 4.5 or higher. Using a USB cable, you can connect the base to a USB-compliant device. When the base is connected to that device, the terminal is connected to the device when seated in the terminal well.

The base acts as a USB device by interfacing the USB signals of the terminal to the USB signals of the host workstation; see [ActiveSync Communication](#) on page 9-8.

Charging a Spare Battery Pack

The [Auxiliary Battery Well](#) (see page 9-3) located on the back panel charges a spare battery. The [AUX Battery LED](#) (page 9-2) on the front panel indicates the charge status of the battery in this well. Charge time is less than four(4) hours and the charge process is independent of the terminal well.

1. Insert the end of the battery without the locking tab into the bottom of the auxiliary well opening.
2. Snap the battery into place with a hinging motion. The Aux Battery LED lights orange.
3. The AUX Battery LED monitors the charge progress.

Bottom Panel Dimensions

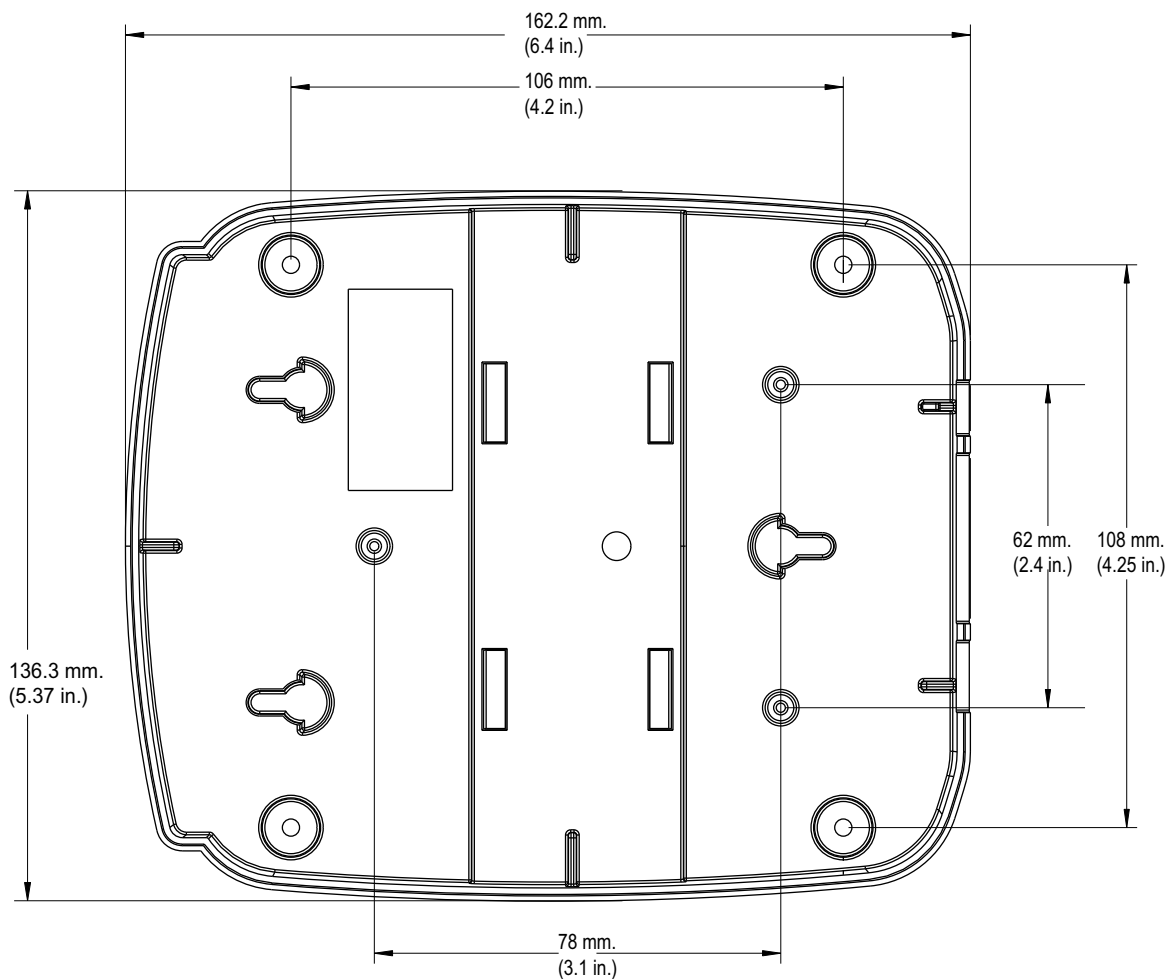

Power

The terminal requires 9.5 volts DC input for communication and battery charging; the power adapter on the power cable converts the voltage from the power source to 9.5 volts DC. Only power adapter cables from Honeywell convert the voltage appropriately.

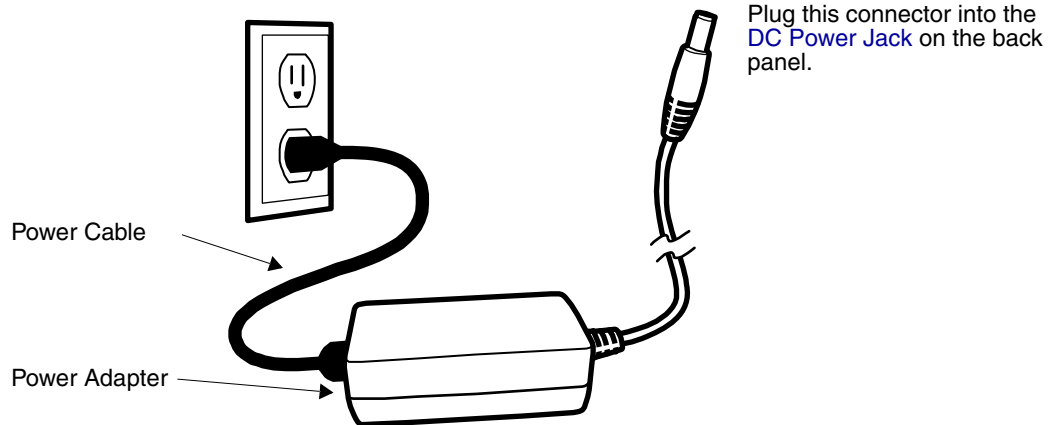

1. Plug the power cable into the power adapter.
2. Plug the power cable into the power source.
3. Plug the connector cable into the DC power jack on the back panel. The base is now powered.

When a terminal is properly seated in the terminal well, the base powers the terminal, charges the terminal's main battery pack, and launches ActiveSync communication (see [ActiveSync Communication](#) on page 9-8).

Honeywell recommends that you leave the base connected to its power source at all times, so that it is always ready to use.

RS-232 Serial Connector

The following diagram displays the pins of the RS-232 serial connector of the [Back Panel](#) (see page 9-3):

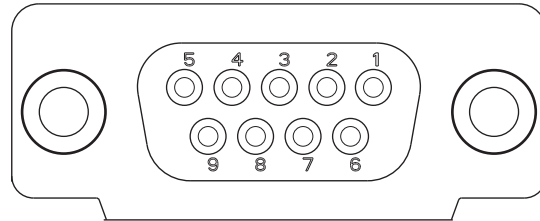

<u>Pin #</u>	<u>Description</u>
1	Internal Jumper to Pin 6
2	TXD
3	RXD
4	DSR
5	GND
6	DTR
7	CTS
8	RTS
9	RI

Note: Signals referenced are for a DTE device. The base is at a right-angle to the printed circuit board (PCB). The ninth pin has a ring indicator (RI).

Charging the Main Battery

The base powers the terminal and fully charges its main battery pack in less than four(4) hours. To check battery power, see [Power](#) on page 6-12.

As battery packs charge, the charging circuitry follows the two-step charging process (CC-CV) that is recommended for Li-ion batteries. This process monitors changes in temperature, current, and voltage.

Inserting a Terminal

1. Install the battery pack in the terminal; see [Install the Main Battery Pack](#) on page 2-1.
2. Power the base; see [Power](#) on page 9-5.
3. Slide the terminal into the terminal well until the Dock LED lights green to indicate that the terminal is properly seated.
4. The battery pack begins charging.

The intelligent battery charging system in the terminal monitors battery power and senses when a full charge has been obtained. When charging is complete, the terminal switches to a trickle charge that keeps the battery at full charge while resting in the base.

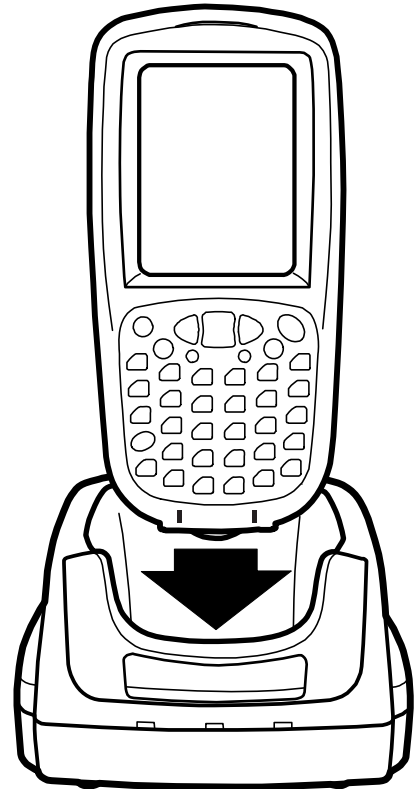

ActiveSync Communication

The Dolphin terminal ships with ActiveSync already installed and defaulted to USB communication. If ActiveSync is not installed on your workstation, you must install it. For details, see [Using ActiveSync](#) on page 7-3.

Communication Types

The base can communicate via USB or RS-232 using ActiveSync 4.5 or higher. However, the base should have only one type of interface cable connected at a time, either USB or RS-232.

USB The [USB Port](#) (see page 9-3) on the back panel allows the terminal to communicate with a workstation or be networked through a USB hub. The base acts as a USB device by interfacing the USB signals of the terminal to the USB signals of the host workstation.

Maximum data transfer rate is 12 Mbps.

RS-232 The [RS-232 Port](#) (see page 9-3) on the back panel allows the terminal to communicate with a workstation, modem, or any RS-232 device using a standard serial cable and communication software.

Maximum data transfer rate is 115 Kbps.

Communicating with the Dolphin Terminal

1. Insert the terminal into the terminal well of the base.
 - The DOCK LED lights green. If not, make sure that the terminal is properly seated. You may need to remove and re-insert the terminal.
 - The terminal activates. If not, verify that the Honeywell power supply is properly connected to the [DC Power Jack](#) (see page 9-3) on the back panel and plugged into a functioning outlet.
2. The terminal and the workstation automatically open ActiveSync to establish a connection.
3. The base can now transfer data between the terminal and the host workstation. If communication does not occur, check the port connections to ensure that the cradle is correctly configured.

Verify Communication

You can verify that the USB driver is functioning by watching the COMM LED on the USB base. When the COMM LED lights solid green, the base is communicating with the workstation.

Verify Data Transfer

The COMM LED flashes when data is being transferred via the base. For an RS-232 connection, the COMM LED flashes red and green. For a USB connection, the COMM LED flashes green.

RS-232 Cables

Connect the base to the host workstation or other device by plugging an RS-232 serial cable into the [RS-232 Port](#) (see page 9-3) on the back panel. The wiring of your cable depends on whether the other device is set up as a Data Communication Equipment (DCE) or Data Terminal Equipment (DTE) device.

The base is configured as a DCE device. To communicate with another DCE device, use either a null modem adapter in line with a standard RS-232 cable, or a null-modem serial cable. To communicate with a DTE device such as a computer, use a standard (or straight-through) RS-232 cable.

You can make your own cables by following the pin configuration in the chart below. To do so, you must determine if your host RS-232 device is 9-pin or 25-pin, and whether it is configured as a DCE or DTE device.

RS-232 Pin Configuration

Host Port (DCE)	IBM AT DB9 (DTE)	IBM XT DB25 (DTE)	Modem DB25 (DCE)
Pin / Input Signal			
2 / (RD)	2	3	2
3 / (TD)	3	2	3
5 / (SG)	5	7	7
4 / (DTR)	4	20	6
6 / (DSR)	6	6	20
7 / (RTS)	7	4	5
8 / (CTS)	8	5	4

*Note: These bases **cannot** be daisy-chained.*

Mounting

Set the base on a dry, stable surface, such as a desktop or workbench near an electrical outlet. Be sure to provide enough workspace with good lighting for the user to view and operate the terminal while it is seated in the base.

Location Recommendations

When choosing a location, bear in mind that:

- the mounting location must allow users easy access to the auxiliary battery well, and
- the serial and USB ports as well as the power jack face straight out of the rear panel, and you will most likely want easy access to them in the future.

Installation Hardware

Screw: 3/16 in. dia x 5/8 in. long pan head screw

Washer: 1/2 in. OD x 7/32 in. ID x 3/64 in. thick

Nut: 3/16 in. dia

Desk Mounting

Charging/communication cradles have a DIN rail (7.5 mm high X 35 mm wide) slot on the bottom to allow for secure desk attachment of the unit if desired.

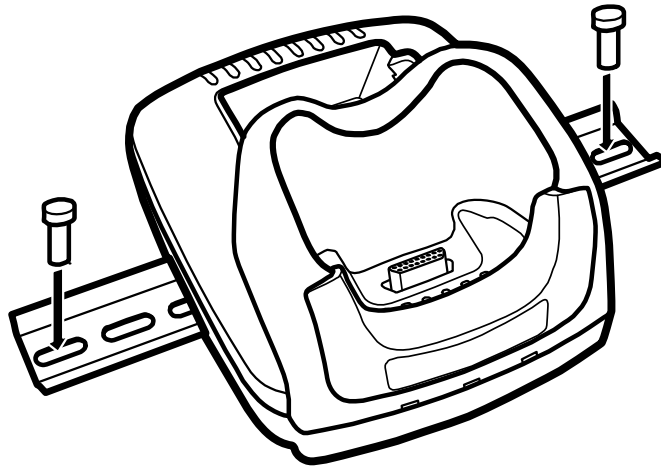

1. Slide the DIN rail slot along the bottom panel.
2. Using the appropriate nuts and bolts, secure the DIN rail to the desk or flat surface.

Note: Use screws that are appropriate for the type of surface (wood or metal, for instance) you are mounting to.

Wall Mounting

You can purchase a wall mount kit that contains

- a mounting bracket,
- three screws, and
- six washer/nut sets.

The back wedge of the mounting bracket contains an open slot for the power and communications cables. There is an extra space between this slot and the rear panel of the base to allow easy access to the power and communications ports. For more details on both ports, see [Back Panel](#) on page 9-3.

To Mount Using the Wall Mount Kit

1. Attach the mounting bracket to the wall using the [Recommended Hardware](#) (see page 9-11).
2. On the base, insert a screw into the round end of each screw slot on the bottom panel. Then, slide each screw towards the narrow end of the slot until it snaps in place.
3. Use a washer/nut set on each of the three screws to secure the screw in the slot.
4. Place the base on the mounting bracket; match the holes up with the secured screws.
5. Use the remaining washer/nut sets on each of the three screws to secure the base to the mounting bracket.

Recommended Hardware

If a metal or wood stud is present, drill a 3/32 in. pilot hole into the stud and use a #6 X 1 1/2 screw and washer to attach the bracket to the wall.

For any of the screws positioned so that they are going directly into dry wall, use a sheet rock anchor/screw set such as the one listed below.

For any of the screws attaching directly into concrete, drill the appropriately sized pilot hole into the concrete and secure the bracket to the wall using concrete anchor screws such as those listed below.

Wall	Recommended Anchors
Sheet Rock	Buildex E-Z Anchor Stud Solver Medium Duty Drywall Anchor (Model #25216); supports 50 lbs., screws included
Concrete	Buildex TAPCON concrete anchors 3/16 in. X at least 1 in.



Overview

The Dolphin QuadCharger device is a four(4)-slot charging station that can charge a Li-ion battery in less than four(4) hours. The fourth slot features a battery analyzer that completely resets and re-calibrates a battery and displays its resulting capacity.

This charger is compatible with the Honeywell Li-ion batteries that power Dolphin 7850 terminals.

Intelligent Battery Charging

Each charging slot works independently of the other three.

As battery packs charge, the charging circuitry follows the two-step charging process (CC-CV) that is recommended for Li-ion batteries. The process monitors changes in temperature, current, and voltage. The charger also resets and calibrates battery pack data.



We recommend use of Honeywell Li-Ion battery packs. Use of any non-Honeywell battery may result in damage not covered by the warranty.

For complete information about batteries, see [Battery Power](#) on page 3-11.



We recommend use of Honeywell peripherals, power cables, and power adapters. Use of any non-Honeywell peripherals, cables, or power adapters may cause damage not covered by the warranty.

Front Panel

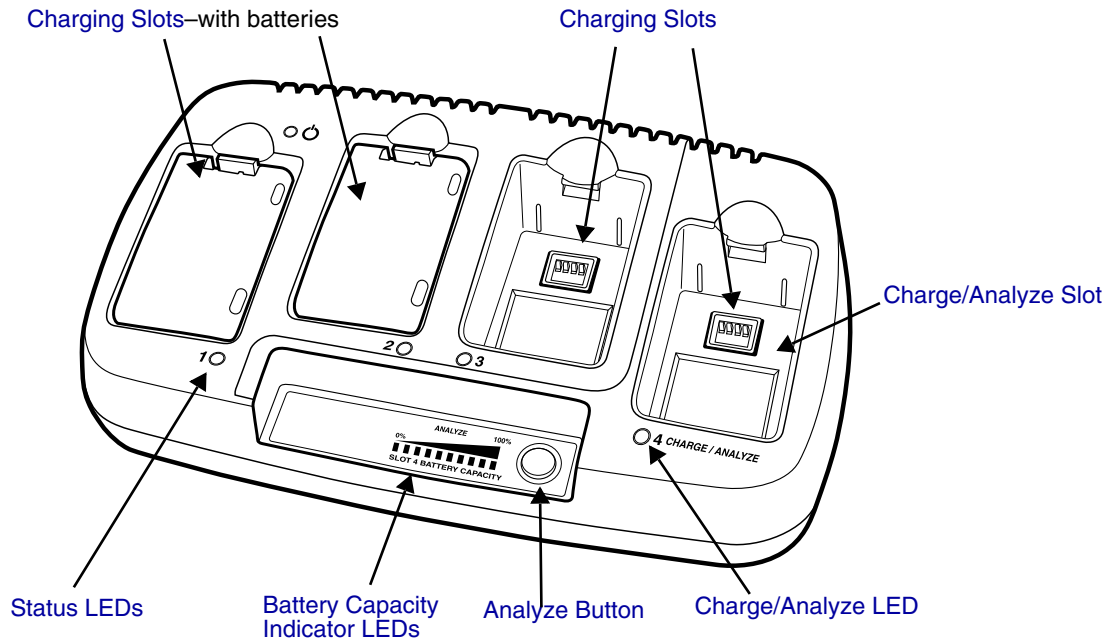

Charging Slots

There are four(4) charging slots. Each slot holds one battery. When a battery is placed in a slot, it immediately begins charging.

Charge/Analyze Slot

This is the fourth slot and the only one that can be used to analyze a battery. When a battery is placed in this slot, it begins charging just as it does in the other three slots. However, if you press the ANALYZE button, it runs the battery in this slot through the complete Analyze cycle. For more information, see [Using the Battery Analyzer](#) on page 10-5.

Battery Capacity Indicator LEDs

These LEDs give a readout of the remaining battery capacity after it has run through a complete analyze cycle. For more information, see [Battery Capacity Indicator LEDs](#) on page 10-2.

Analyze Button

Press this button to start a battery analyze cycle; see [Using the Battery Analyzer](#) on page 10-5.

Status LEDs

A status LED is located above each of the four(4) battery slots. The color of the LED indicates the charge status of the batteries in its slot.

Green	The battery in the slot has completed its charge cycle and is ready to use.
Orange	The battery in the slot is being charged at a maximum charge rate.
Red	The battery in the slot encountered an error during the most recent charge cycle.

Back Panel

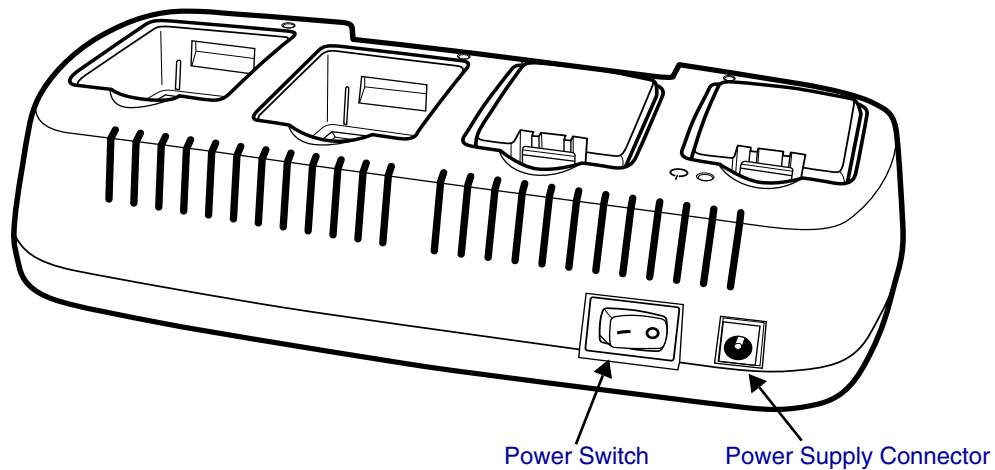

Power Supply Connector

Use this connector to attach the power supply to the charger.
The universal power supply accepts input voltages between 90-265 volts.

Power Switch

Toggle the power switch to turn the charger on and off.

Inserting and Removing Battery Packs

To insert a battery pack, place the end of the battery without the locking tab into the bottom of the charging pocket and snap the battery into place with a hinging motion. The Status LED for that particular slot lights orange when the battery has been properly inserted. To remove a battery pack, push the locking tab down and pull the battery out from the charging slot with a hinging motion.

Supplying Power

Use the power adapter cable that comes with the charger so that the input voltage is adjusted appropriately.

1. Locate the AC power adapter cable and plug it into the power source.
2. Connect the power cable to the power adapter.
3. Connect the power cable to the supply connector on the back of the charger.
4. Press the power switch to the ON position.
The power LED lights green, and the charger performs a self-diagnostic test that lasts approximately five seconds.

Charging Batteries

For best results, battery packs should be at room temperature before recharging them because temperature impacts charging. The recommended temperature range is 50° to 95° F (10° to 35° C).

1. Supply power and turn the power switch to the ON position.
2. Insert batteries into the appropriate slots. The Status LED for each slot turns orange to indicate that the battery has begun a charge cycle.
3. When the Status LED turns green, the battery in the slot has completed charging.

Recommendations for Storing Batteries

To maintain top performance from batteries, follow these storage guidelines:

- Avoid storing batteries outside of the specified temperature range of -4° to 104° F (-20° to 40°C) or in extremely high humidity.
- For prolonged storage, do not keep batteries stored in a charger that is connected to a power source.

Using the Battery Analyzer

The fourth charging slot is also the CHARGE/ANALYZE slot because, in addition to charging a Li-ion battery, this slot runs an Analyze cycle on the battery placed in it, which helps you monitor battery capacity over time.

Analyze Button

The Analyze cycle is initiated when a battery is placed in the Charge/Analyze slot and the **Analyze** button is pressed. In an Analyze cycle, batteries are completely discharged, then recharged to capacity. The battery is completely reset and re-calibrated.

The amount of time required for a battery to complete the Analyze cycle depends on initial state of the battery's charge. Minimum time is **8 hours**, maximum time is **12 hours**.

Battery Capacity Indicator LEDs

These LEDs display the charge capacity of the battery at the end of the Analyze cycle. Battery capacity is displayed as a percentage of measured capacity/rated capacity where each LED equals 10% battery capacity. At the end of the Analyze cycle, these LEDs display the maximum charge level the battery can now hold.

Status LED

The Charge/Analyze slot also contains a standard status LED in the upper, left corner of the slot. When this slot is used for regular charging, this LED operates in the usual manner; see [Status LEDs](#) on page 10-2.

When this slot is being used to analyze a battery, its status LED functions as follows:

Solid Green	The battery has completed the Analyze cycle.
Flashing Orange	The battery is currently being analyzed.
Solid Red	The charger encountered an error during the Analyze cycle.

To Analyze a Battery

1. Insert the battery into the Charge/Analyze slot (the fourth).
2. Press the [Analyze Button](#) (page 10-2). The Status LED flashes orange to indicate that the analyzing cycle has begun.
3. Upon completion of the Analyze cycle, the Status LED lights solid green, and the Battery Capacity Indicator LEDs display the battery's capacity.



The Charge/Analyze slot is accumulating battery pack information during the entire Analyze cycle. Do NOT remove the battery until the cycle has been completed.

Bottom Panel

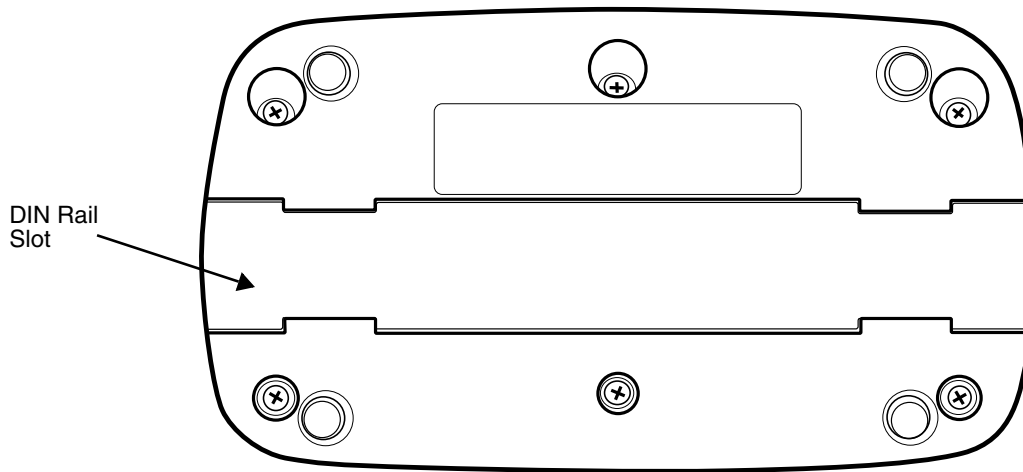

Mounting

The charger should be on a dry, stable surface. To easily adapt the charger to your environment, it can be mounted on a flat, horizontal surface such as a desktop or workbench, or a flat, vertical surface such as a wall.

When choosing a location, always bear in mind that

- the mounting location must allow users easy access to power switch and power connector.
- the charger should be oriented so that users can easily insert and remove battery packs and read the labels, especially for the Battery Analyzer.

Using the DIN Rail

Most Dolphin peripherals have a DIN Rail (7.5 mm high X 35 mm wide) slot on the bottom panel to enable secure mounting.

To mount the charger, you slide the DIN Rail into the slot on the bottom panel. Then, using the appropriate nuts and bolts, secure the DIN rail to the desk or wall.

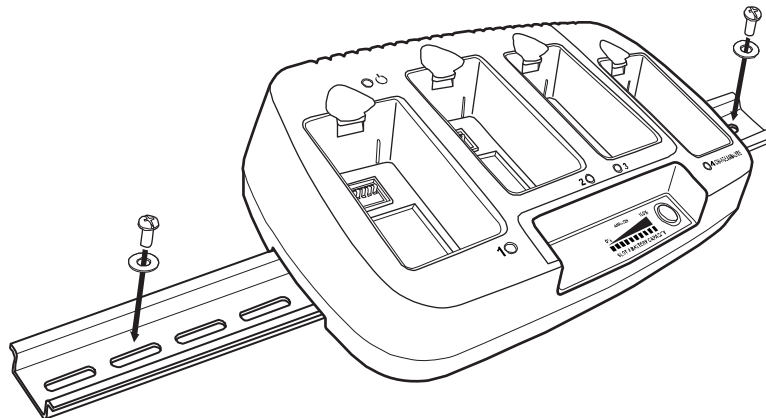

Troubleshooting

If you encounter problems with your charger, refer to chart below for possible solutions. If problems persist, please contact [Limited Warranty](#) (see page 13-2).

Problem	Issue
The Status LED does not come on when I insert a battery pack.	Check the power connections; make sure the POWER switch is ON and the battery pack is properly seated.
The Status LED lights red during charging.	Try to charge the battery in one of the other charging slots. If the Status LED lights red again, then the problem is associated with the battery pack.
The Status LED lights red and stays on without a battery in the charging slot.	An error occurred during the self-diagnostic test for that particular charging pocket. Call Honeywell Product Service and request an RMA. For additional warranty and return information, see Customer Support and Warranty on page 13-1.



Dolphin ChargeBase Device

Overview

This four-slot charging cradle that can power four(4) Dolphin terminals, and charge their main batteries in less than four(4) hours. Each charging slot charges terminals independently of the other slots.

Charging

The ChargeBase completes a full charge of the main battery pack in less than four(4) hours. The ChargeBase also provides power to the intelligent battery charging system in all Dolphin terminals that senses when a full charge has been achieved and switches to a trickle charge to maintain the full charge. As battery packs charge, the charging circuitry follows the two-step charging process (CC-CV) that is recommended for li-ion batteries. The process monitors changes in temperature, current, and voltage.

Convenient Storage

Intelligent battery charging makes the ChargeBase a safe and convenient storage receptacle for Dolphin terminals.



We recommend use of Honeywell Li-Ion battery packs. Use of any non-Honeywell battery may result in damage not covered by the warranty.

For complete information about batteries, see [Battery Power](#) on page 3-11.



We recommend use of Honeywell peripherals, power cables, and power adapters. Use of any non-Honeywell peripherals, cables, or power adapters may cause damage not covered by the warranty.

Front Panel

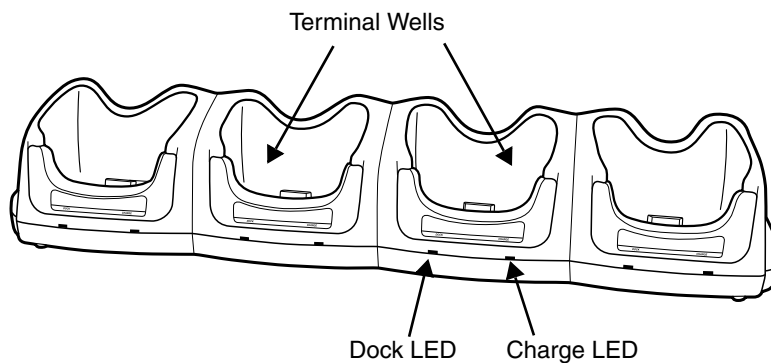

Terminal Wells

The ChargeBase contains four(4) terminals wells. Each terminal well

- Holds and charges the main battery pack of one Dolphin terminal.
- Contains the companion to the I/O connector on the bottom panel of Dolphin terminals.
- Has two LEDs on the front: the Dock LED and the Charge LED.

Dock LED

Each terminal well displays a Dock LED on the front that lights solid green when a terminal is properly seated, which means that the terminal and the base are connected.

Charge LEDs

Each terminal well displays a Charge LED on the front that lights green to indicate charging. For details, see [Charging Terminals in the ChargeBase](#) on page 11-5.

Back Panel

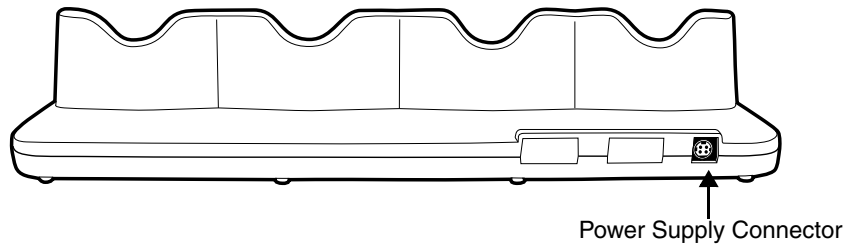

Power Supply Connector

This connector receives input from the power adapter. Plug the power connector cable from the power adapter into this connector. There is no ON/OFF switch on the back panel of the base. The ON/OFF switch is on the power adapter.

Power Supply

The base includes a power supply that contains a power adapter to ensure the proper voltage. The power adapter plugs into standard AC/DC outlets.

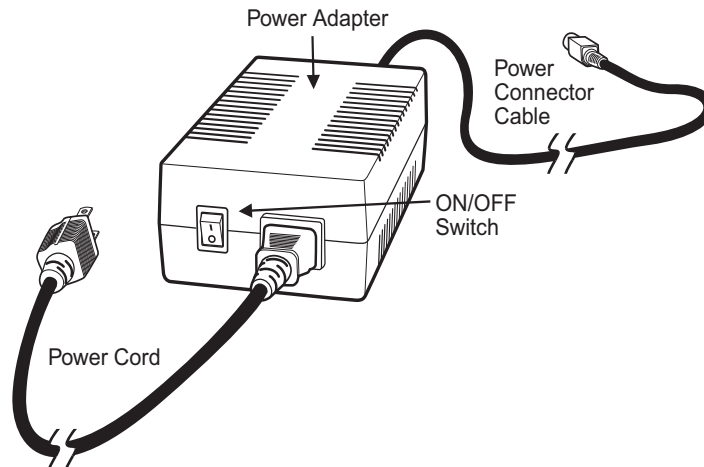

Supplying Power to the ChargeBase

 Use only the peripherals, power cables, and power adapters from Honeywell. Use of peripherals, cables, or power adapters not sold/manufactured by Honeywell may cause damage not covered by the warranty.

1. Be sure the power switch on the power adapter is in the OFF position.
2. Plug the power cord into the power adapter.
3. Plug the power connector cable into the power connector on the back panel of the base.
4. Plug the power cord into a standard wall outlet.
5. On the power adapter, turn the power switch to the ON position. The LEDs light as the base powers up.
6. The base is ready to begin charging terminals.

Inserting and Removing Terminals

To insert a terminal, hold the terminal with the bottom panel perpendicular to the base. Slide the terminal into the well until the Dock LED lights solid green. Charging begins immediately.

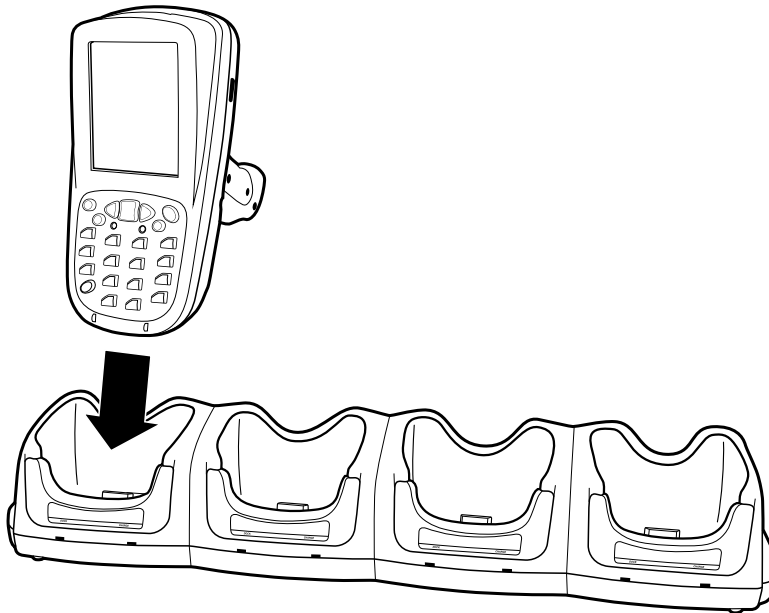

To remove a terminal, grasp it firmly in your hand and lift it up and out of the terminal well. The LEDs for the terminal well turns off.

Charging Terminals in the ChargeBase

The ChargeBase charges the main battery of each terminal in less than four(4) hours. The intelligent battery charging system incorporated in the Dolphin terminal prevents overcharging, which means that Dolphin terminals may be stored in the ChargeBase indefinitely without damage to the terminals, battery packs, or the ChargeBase.

1. Power the ChargeBase; see [Supplying Power to the ChargeBase](#) on page 11-4.
2. Insert a terminal into a terminal well; see [Inserting and Removing Terminals](#) on page 11-4.
3. The Charge LED lights green to indicate that the terminal is powered and charging.

Mounting the ChargeBase

The ChargeBase should be placed on a dry, stable surface. To easily adapt the ChargeBase to your environment, it can be mounted on a flat, horizontal surface such as a desktop or workbench, or a flat, vertical surface such as a wall.

Location Recommendations

When choosing a location, always bear in mind that

- The mounting location must allow users easy access to the power connector.
- The ChargeBase should be oriented so that users can easily read the labels.

Installation Hardware

Screw: 3/16 in. dia x 5/8 in. long pan head screw

Washer: 1/2 in. OD x 7/32 in. ID x 3/64 in. thick

Nut: 3/16 in. dia

Bottom Panel

The bottom panel of the ChargeBase offers two mounting options: insert a DIN Rail in the available slot for desk mounting or secure two mounting brackets with the available screw slots.

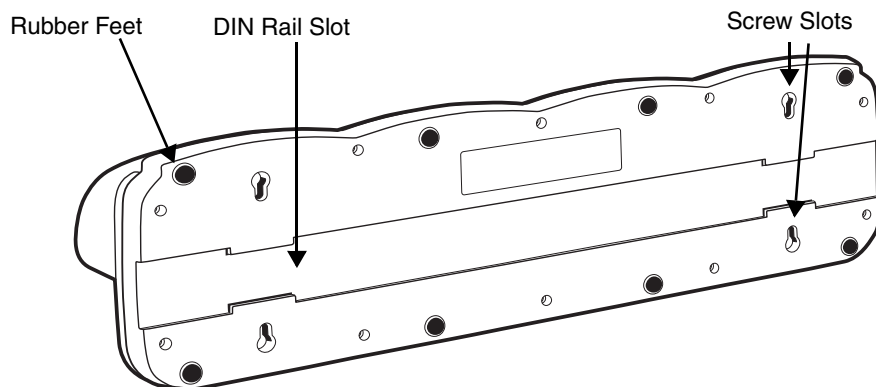

Using the DIN Rail

Charging/communication cradles have a slot for a 7.5mm (high) X 35mm (wide) DIN rail on the bottom panel that enables you to mount to a desk or secure, flat surface.

1. Slide the DIN Rail into the DIN Rail slot on the bottom panel.

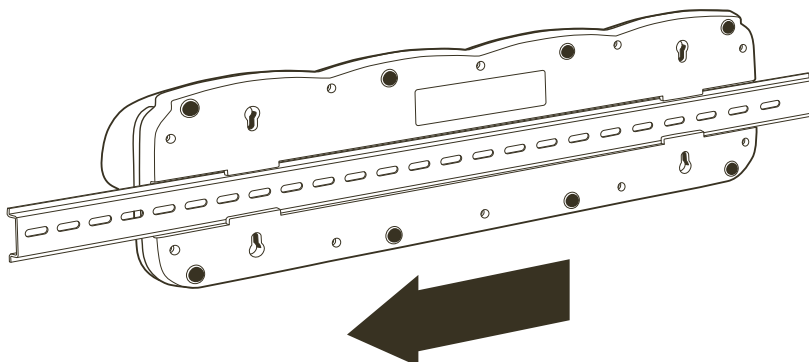

-
2. Turn the ChargeBase and DIN Rail right side up.
 3. Secure the DIN Rail to a stable, flat horizontal surface.

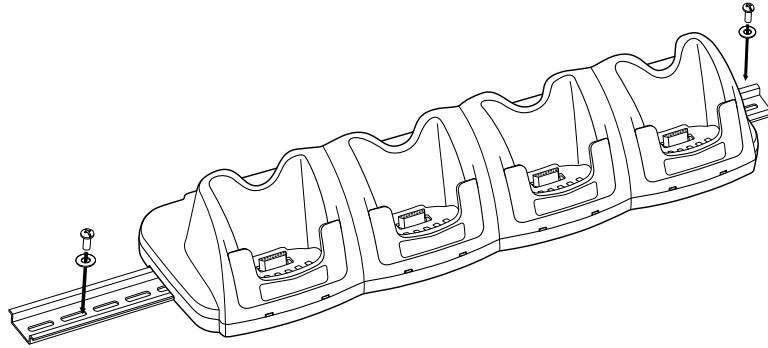

Wall Mounting

You need to purchase **two** wall mount kits that each contain:

- a mounting bracket,
- three screws, and
- six washer/nut sets.

You need two kits so that you have two mounting brackets—one for each end of the device—and enough screws (4) and washer/nut sets (8).

The mounting bracket contains an open slot between the back and bottom wedges to accommodate the connector cables.

To Mount

1. Attach the mounting bracket to the wall using the [Recommended Hardware](#) (see page 11-8).
2. On each end of the base, insert a screw into the round end of each of the 4 screw slots on the bottom panel. Then, slide each screw towards the narrow end of the slot until it snaps in place.
3. Use a washer/nut set on each of the 4 screws to secure the screw in the slot.
4. Place the base on the mounting bracket; match the holes up with the secured screws.
5. Use the remaining washer/nut sets on each of the 4 screws to secure the base to the mounting bracket.

Recommended Hardware

If a metal or wood stud is present, drill a 3/32 in. pilot hole into the stud and use a #6 X 1 1/2 screw and washer to attach the bracket to the wall.

For any of the screws positioned so that they are going directly into dry wall, use a sheet rock anchor/screw set such as the one listed below.

For any of the screws attaching directly into concrete, drill the appropriately sized pilot hole into the concrete and secure the bracket to the wall using concrete anchor screws such as those listed below.

Wall	Recommended Anchors
Sheet Rock	Buildex E-Z Anchor Stud Solver Medium Duty Drywall Anchor (Model #25216); supports 50 lbs., screws included
Concrete	Buildex TAPCON concrete anchors 3/16 in. X at least 1 in.

Cables

There are several cable kits for Dolphin 7850 terminals.

Cable	Description	See Page
Power Cable	Charge-only cable that plugs into the DC Power Jack (see page 3-5) on the pistol-grip handle.	12-2
Mobile Charger	Charge-only cable that connects the terminal to a vehicle power outlet.	12-3
Comm/Charge Cable	Communication/Charge cable that connects the terminal to an external power source and a host workstation.	12-4



We recommend use of Honeywell peripherals, power cables, and power adapters. Use of any non-Honeywell peripherals, cables, or power adapters may cause damage not covered by the warranty.

Universal Cable Features

In addition to the hardware peripherals, there are several cables you can use with the terminal depending on what the needs of your work environment.

Intelligent Battery Charging

Dolphin terminals, peripherals, and cables are designed with an intelligent battery charging system that protects the battery from being damaged by overcharging. When a battery pack is fully charged, the charge process automatically switches to a trickle charge that maintains the battery at full capacity. As a result, Dolphin terminals may be connected to Dolphin cables indefinitely.

Voltage

All Dolphin power cables contain a power adapter that converts the voltage from the power source to 9.5 volts DC, which is the maximum voltage the terminal can receive.

Using the Power Cable

The Power Cable connects the terminal to an external power source via the DC jack on the bottom panel of the pistol-grip handle.

DC Power Jack

(Pull back the rubber flap to gain access to the power jack.)

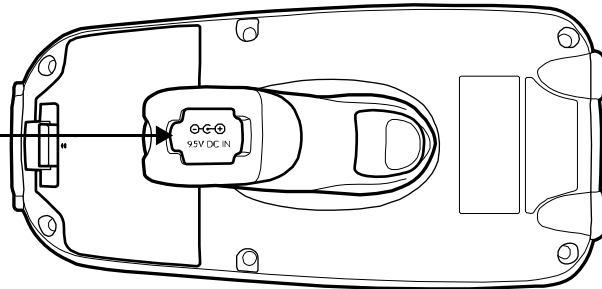

The Power Cable contains a power adapter that converts the voltage from the power source to 9.5 volts DC, which is the maximum voltage the terminal can receive.

Using the Power Cable

1. Set the terminal down on its rubber bumpers; see [I/O Connector](#) on page 3-9.

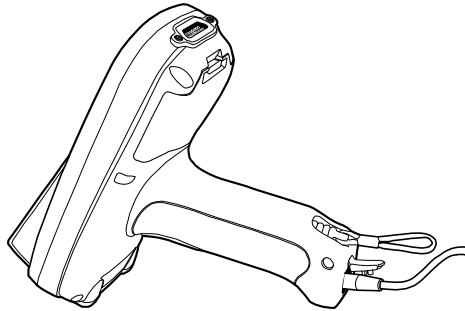

2. Pull back the flap of the DC power jack and plug the power cable into the jack.
3. Plug the power adapter into a standard power outlet.

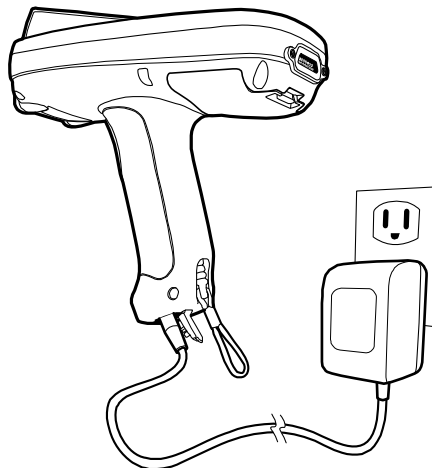

4. The terminal switches to external power and the main battery begins charging. The terminal is ready for use.

Using the Mobile Charger

The Mobile Charger connects the terminal to a vehicle power source. This cable powers the terminal and charges the main battery pack.

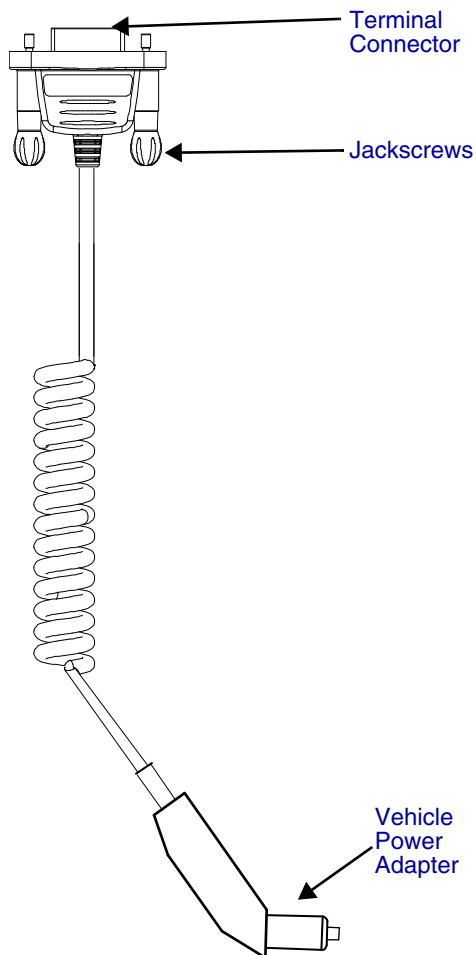

Terminal Connector

The terminal connector connects the communication cable to the I/O connector (see [I/O Connector](#) on page 3-9) on the terminal.

The pins in this connector work only with the I/O connector on the terminal.

Jackscrews

The jackscrews secure the terminal connector to the I/O connector on the terminal.

Once the terminal connector is plugged into the I/O connector on the bottom panel of the terminal, turn both jackscrews to the right to secure the connection.

Vehicle Power Adapter

The vehicle power adapter plugs into a standard vehicle power source and converts voltage to the 9.5 volts DC required by the terminal.

Using the Mobile Charger Inside a Vehicle

Using the Mobile Charger in combination with the Mobile Mount powers and secures the terminal inside a vehicle.

1. Insert the terminal into the Mobile Mount.
2. Install the Mobile Mount inside the vehicle.
3. Plug the [Terminal Connector](#) (see page 12-3) of the Mobile Charger into the I/O connector on the bottom panel of the terminal.
4. Tighten the [Jackscrews](#) (see page 12-3).
5. Plug the [Vehicle Power Adapter](#) (see page 12-3) into the vehicle power outlet.

Note: Dolphin terminals contain an intelligent battery charging system that monitors the charging of the battery pack to protect the battery from damage by overcharging if left connected to a charging peripheral indefinitely.

Using the Comm/Charge Cable

The Comm/Charge cable charges the terminal and communicates with a host workstation. There are three connectors: one connects the terminal to an external power source, another to the host workstation, and another to the terminal itself.

This cable is actually two cables: a power cable and a communication cable. You can use it to charge only, communicate only or connect the cables to each other to charge and communicate at the same time.

Communication Cable

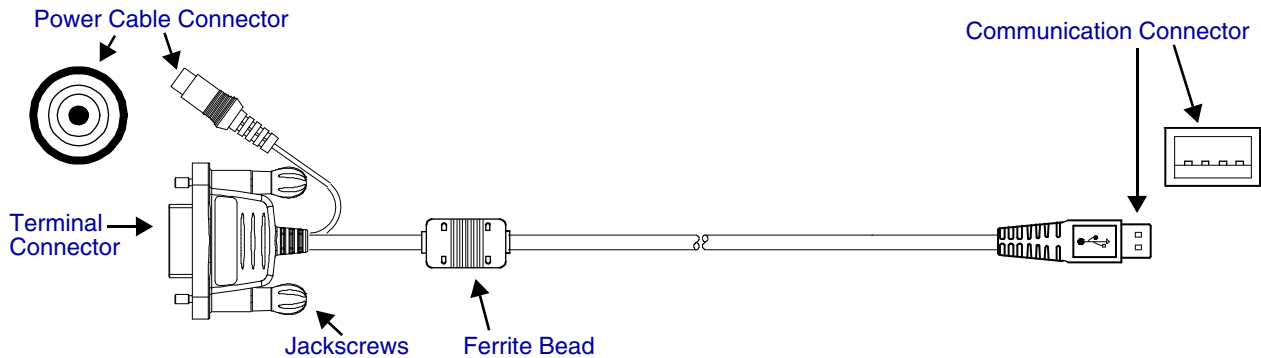

Communication Connector

The communication connector connects the terminal to a host device via USB (v1.1 or higher) or RS-232; USB is shown above. Plug this connector directly into a host workstation, then establish [ActiveSync Communication](#) (see page 12-5).

The USB plug has four(4) pins and fits into standard desktop computers and laptops.

Ferrite Bead

This is a Urite ferrite bead.

Jackscrews

The jackscrews secure the terminal connector to the I/O connector on the terminal. Once the terminal connector is plugged into the I/O connector on the bottom panel of the terminal, turn both jackscrews to the right to secure the connection.

Power Cable Connector

The power cable connector connects the charge cable to the power cable. The power cable powers the terminal and charges the main battery pack.

The power adapter on the power cable is available in US, UK, and EMEA versions. All version convert the voltage from the power source to 9.5 volts DC, which is the maximum voltage the terminal can receive.

Terminal Connector

The terminal connector connects the communication cable to the (see [I/O Connector](#) on page 3-9) on the bottom panel of the terminal. The pins in the terminal connector work only with the I/O connector on the terminal. After connecting the pins, secure the cable to the terminal by turning both jackscrews to the right.

Using the Comm/Charge Cable

1. Plug the cable's terminal connector into the I/O connector on the bottom panel of the terminal.
2. Tighten the jackscrews.
3. Plug the power cable connector into the power cable.
4. Plug the power adapter on the power cable into a standard power outlet.
5. Plug the communication connector into the host workstation.
6. Establish the [ActiveSync Communication](#) (see page 12-5).

ActiveSync Communication

After the terminal is connected to a power source and the host workstation, you need to set up both the terminal and the host workstation for ActiveSync communication.

Setting up ActiveSync for the comm/charge cable is the same as for the Dolphin HomeBase device, which also has a USB and an RS-232 version. For details, see [Using ActiveSync](#) on page 7-3.

Default ActiveSync Communication Values

The default workstation synchronization value for USB communication is '**USB Connection**'.

The default workstation synchronization value for RS-232 communication is '**115200 Default**'.



Technical Assistance

If you need assistance installing or troubleshooting your device, please call your distributor or the nearest technical support office:

North America/Canada

Telephone: (800) 782-4263
E-mail: hsmnasupport@honeywell.com

Latin America

Telephone: (803) 835-8000
Telephone: (800) 782-4263
E-mail: hsmlasupport@honeywell.com

Brazil

Telephone: +55 (11) 5185-8222
Fax: +55 (11) 5185-8225
E-mail: brsuporte@honeywell.com

Mexico

Telephone: 01-800-HONEYWELL (01-800-466-3993)
E-mail: soporte.hsm@honeywell.com

Europe, Middle East, and Africa

Telephone: +31 (0) 40 7999 393
Fax: +31 (0) 40 2425 672
E-mail: hsmeurosupport@honeywell.com

Hong Kong

Telephone: +852-29536436
Fax: +852-2511-3557
E-mail: aptechsupport@honeywell.com

Singapore

Telephone: +65-6842-7155
Fax: +65-6842-7166
E-mail: aptechsupport@honeywell.com

China

Telephone: +86 800 828 2803
Fax: +86-512-6762-2560
E-mail: aptechsupport@honeywell.com

Japan

Telephone: +81-3-3839-8511
Fax: +81-3-3839-8519
E-mail: aptechsupport@honeywell.com

Online Technical Assistance

You can also access technical assistance online at www.honeywellaidc.com.

Product Service and Repair

Honeywell International Inc. provides service for all its products through service centers throughout the world. To obtain warranty or non-warranty service, contact the appropriate location below to obtain a Return Material Authorization number (RMA #) before returning the product.

North America

Telephone: (800) 782-4263
E-mail: hsmnaservice@honeywell.com

Latin America

Telephone: (803) 835-8000
Telephone: (800) 782-4263
Fax: (239) 263-9689
E-mail: laservice@honeywell.com

Brazil

Telephone: +55 (11) 5185-8222
Fax: +55 (11) 5185-8225
E-mail: brservice@honeywell.com

Mexico

Telephone: 01-800-HONEYWELL (01-800-466-3993)
Fax: +52 (55) 5531-3672
E-mail: mxservice@honeywell.com

Europe, Middle East, and Africa

Telephone: +31 (0) 40 2901 633
Fax: +31 (0) 40 2901 631
E-mail: eurosservice@honeywell.com

Hong Kong

Telephone: +852-29536436
Fax: +852-2511-3557
E-mail: apservice@honeywell.com

Singapore

Telephone: +65-6842-7155
Fax: +65-6842-7166
E-mail: apservice@honeywell.com

China

Telephone: +86 800 828 2803
Fax: +86-512-6762-2560
E-mail: apservice@honeywell.com

Japan

Telephone: +81-3-3839-8511
Fax: +81-3-3839-8519
E-mail: apservice@honeywell.com

Online Product Service and Repair Assistance

You can also access product service and repair assistance online at www.honeywellaidc.com.

Limited Warranty

Honeywell International Inc. ("HII") warrants its products to be free from defects in materials and workmanship and to conform to HII's published specifications applicable to the products purchased at the time of shipment. This warranty does not cover any HII product which is (i) improperly installed or used; (ii) damaged by accident or negligence, including failure to follow the proper maintenance, service, and cleaning schedule; or (iii) damaged as a result of (A) modification or alteration by the purchaser or other party, (B) excessive voltage or current supplied to or drawn from the interface connections, (C) static electricity or electro-static discharge, (D) operation under conditions beyond the specified operating parameters, or (E) repair or service of the product by anyone other than HII or its authorized representatives.

This warranty shall extend from the time of shipment for the duration published by HII for the product at the time of purchase ("Warranty Period"). Any defective product must be returned (at purchaser's expense) during the Warranty Period to HII's factory or authorized service center for inspection. No product will be accepted by HII without a Return Materials Authorization, which may be obtained by

contacting HII. In the event that the product is returned to HII or its authorized service center within the Warranty Period and HII determines to its satisfaction that the product is defective due to defects in materials or workmanship, HII, at its sole option, will either repair or replace the product without charge, except for return shipping to HII.

EXCEPT AS MAY BE OTHERWISE PROVIDED BY APPLICABLE LAW, THE FOREGOING WARRANTY IS IN LIEU OF ALL OTHER COVENANTS OR WARRANTIES, EITHER EXPRESSED OR IMPLIED, ORAL OR WRITTEN, INCLUDING, WITHOUT LIMITATION, ANY IMPLIED WARRANTIES OF MERCHANTABILITY OR FITNESS FOR A PARTICULAR PURPOSE.

HII'S RESPONSIBILITY AND PURCHASER'S EXCLUSIVE REMEDY UNDER THIS WARRANTY IS LIMITED TO THE REPAIR OR REPLACEMENT OF THE DEFECTIVE PRODUCT WITH NEW OR REFURBISHED PARTS. IN NO EVENT SHALL HII BE LIABLE FOR INDIRECT, INCIDENTAL, OR CONSEQUENTIAL DAMAGES, AND, IN NO EVENT, SHALL ANY LIABILITY OF HII ARISING IN CONNECTION WITH ANY PRODUCT SOLD HEREUNDER (WHETHER SUCH LIABILITY ARISES FROM A CLAIM BASED ON CONTRACT, WARRANTY, TORT, OR OTHERWISE) EXCEED THE ACTUAL AMOUNT PAID TO HII FOR THE PRODUCT. THESE LIMITATIONS ON LIABILITY SHALL REMAIN IN FULL FORCE AND EFFECT EVEN WHEN HII MAY HAVE BEEN ADVISED OF THE POSSIBILITY OF SUCH INJURIES, LOSSES, OR DAMAGES. SOME STATES, PROVINCES, OR COUNTRIES DO NOT ALLOW THE EXCLUSION OR LIMITATIONS OF INCIDENTAL OR CONSEQUENTIAL DAMAGES, SO THE ABOVE LIMITATION OR EXCLUSION MAY NOT APPLY TO YOU.

All provisions of this Limited Warranty are separate and severable, which means that if any provision is held invalid and unenforceable, such determination shall not affect the validity of enforceability of the other provisions hereof.

Use of any peripherals not provided by the manufacturer may result in damage not covered by the warranty. This includes but is not limited to: cables, power supplies, cradles, and docking stations.

Honeywell International Inc. extends these warranties only to users of the products. These warranties are non-transferable.

The limited duration of the warranty for the Dolphin 7850 series of products is as follows:

- Terminals with an integrated imager are covered by a two-year limited warranty.
- Dolphin HomeBase device, Dolphin QuadCharger device, Dolphin ChargeBase, and Dolphin Mobile Charger are covered by a one-year limited warranty.

Use of any battery from a source other than Honeywell may result in damage not covered by the warranty. Batteries returned to Honeywell International Inc. in a reduced state may or may not be replaced under this warranty. Battery life will be greatly increased when following the battery instructions in this user's guide.

How to Extend Your Warranty

Honeywell International Inc. offers a variety of service plans on our hardware products. These agreements offer continued coverage for your equipment after the initial warranty expires. For more information, contact your Sales Representative, Customer Account Representative, or Product Service Marketing Manager from Honeywell International Inc., or your Authorized Reseller.



Honeywell Scanning & Mobility
9680 Old Bailes Road
Fort Mill, SC 29707

www.honeywellaidc.com